

Oxygen meter for dissolved oxygen  
with integrated temperature and pressure measuring

As of Version 1.0

Operating manual

# GMH 3611



Please keep for future reference!



WEEE-Reg.-Nr. DE 93889386

# Contents

<b>1</b>	<b>GENERAL NOTE</b> .....	<b>2</b>
<b>2</b>	<b>DESIGNATED USE</b> .....	<b>3</b>
<b>3</b>	<b>SAFETY</b> .....	<b>3</b>
3.1	SAFETY SIGNS AND SYMBOLS .....	3
3.2	SAFETY GUIDELINES .....	3
<b>4</b>	<b>PRODUCT DESCRIPTION</b> .....	<b>4</b>
4.1	SCOPE OF SUPPLY .....	4
4.2	OPERATION AND MAINTENANCE ADVICE .....	4
4.3	START OF OPERATION .....	4
4.4	CONNECTIONS .....	5
4.5	DISPLAY ELEMENTS .....	5
4.6	PUSHBUTTONS .....	5
4.7	POP-UP CLIP .....	6
<b>5</b>	<b>CONFIGURATION</b> .....	<b>7</b>
<b>6</b>	<b>THE OXYGEN SENSOR</b> .....	<b>8</b>
6.1	DESIGN OF SENSOR GWO 3600 .....	8
6.2	ELECTRODE MAINTENANCE .....	8
<b>7</b>	<b>OXYGEN MEASURING - PLEASE NOTE</b> .....	<b>9</b>
7.1	AMBIENT PRESSURE AND MEASURING DEPTH OF THE ELECTRODE .....	9
7.2	CORRECTION OF SALINITY ('SAL') .....	9
<b>8</b>	<b>CALIBRATION OF THE SENSOR</b> .....	<b>9</b>
8.1	HOW TO CALIBRATE .....	9
8.2	EVALUATION OF SENSOR STATE (ELEC) .....	10
8.3	CALIBRATION INTERVAL (C.int) .....	10
<b>9</b>	<b>INSPECTION OF THE ACCURACY / ADJUSTMENT SERVICES</b> .....	<b>11</b>
<b>10</b>	<b>SERIAL INTERFACE</b> .....	<b>11</b>
<b>11</b>	<b>ERROR AND SYSTEM MESSAGES</b> .....	<b>12</b>
<b>12</b>	<b>SPECIFICATION</b> .....	<b>13</b>
<b>13</b>	<b>RESHIPMENT AND DISPOSAL</b> .....	<b>13</b>

## 1 General Note

Read this document carefully and get used to the operation of the device before you use it. Keep this document within reach for consulting in case of doubt.

If the device is stored at temperatures above 50°C the battery has to be removed from the device.

**NOTE:** *We recommend taking out battery if device is not used for a longer period of time.  
Risk of leakage!*



## 2 Designated Use

The GMH 3611 is measuring dissolved oxygen in Water.

The measuring is performed by means of a suitable oxygen sensor (included in supply in standard instrument) connected to the Mini-DIN socket, the sensor measures at the membrane at the tip of the sensor. Due to the properties of the sensor, it has to be calibrated regularly (e.g. at fresh air = 20.95%) to get precise values. If the sensor is used up, this will be detected during the calibration, the sensor has to be regenerated or replaced before continuing with measuring.

The safety requirements (see below) have to be observed.

The device must be used only according to its intended purpose and under suitable conditions.

Use the device carefully and according to its technical data (do not throw it, strike it, ...)

Protect the device from dirt.

## 3 Safety

### 3.1 Safety signs and symbols

Warnings are labeled in this document with the followings signs:



**Caution!** This symbol warns of imminent danger, death, serious injuries and significant damage to property at non-observance.



**Attention!** This symbol warns of possible dangers or dangerous situations which can provoke damage to the device or environment at non-observance.



**Note!** This symbol point out processes which can indirectly influence operation or provoke unforeseen reactions at non-observance.

### 3.2 Safety guidelines

This device has been designed and tested in accordance with the safety regulations for electronic devices. However, its trouble-free operation and reliability cannot be guaranteed unless the standard safety measures and special safety advises given in this manual will be adhered to when using the device.

1. Trouble-free operation and reliability of the device can only be guaranteed if the device is not subjected to any other climatic conditions than those stated under "Specification".  
If the device is transported from a cold to a warm environment condensation may cause in a failure. In such case make sure the device temperature has adjusted to the ambient before trying a new start-up.

2.  If there is a risk whatsoever involved in running it, the device has to be switched off immediately and to be marked accordingly to avoid re-starting.



Operator safety may be a risk if:

- there is visible damage to the device
- the device is not working as specified
- the device has been stored under unsuitable conditions for a longer time.

In case of doubt, please return device to manufacturer for repair or maintenance.

3.  Do not use these products as safety or emergency stop devices or in any other application where failure of the product could result in personal injury or material damage.  
Failure to comply with these instructions could result in death or serious injury and material damage.



4.  This device must not be used at potentially explosive areas! The usage of this device at potentially explosive areas increases danger of deflagration, explosion or fire due to sparking.



## 4 Product Description

### 4.1 Scope of supply

The scope of supply includes:

- GMH 3651 with 9V-battery
- Operating Manual

The necessary oxygen sensor is chosen separately due to application.

### 4.2 Operation and maintenance advice

#### 1. Battery operation

If  and 'bAt' are shown in the lower display the battery has been used up and needs to be replaced. However, the device will operate correctly for a certain time. If 'bAt' is shown in the upper display the voltage is too low to operate the device; the battery has been completely used up.



The battery has to be taken out, when storing device above 50 °C.

We recommend taking out battery if device is not used for a longer period of time.

After recommissioning the real-time clock has to be set again.

#### 2. Mains operation with power supply

When using a power supply please note that operating voltage has to be 10.5 to 12 V DC.



Do not apply overvoltage!! Cheap 12V-power supplies often have excessive no-load voltage.

We, therefore, recommend using regulated voltage power supplies.

Trouble-free operation is guaranteed by our power supply GNG10/3000.

Prior to connecting the power supply to the mains make sure that the operating voltage stated at the power supply is identical to the mains voltage.

#### 3. Treat device and sensor carefully. Use only in accordance with above specification. (do not throw, hit against etc.). Protect plug and socket from soiling.

### 4.3 Start of Operation

Switch the device on with the key "ON OFF". The instrument is performing a self diagnosis, during this time all display segments are shown.

Afterwards the instrument signals, if it was user adjusted („Err“)

The device starts measurement afterwards.

### 4.4 Connections

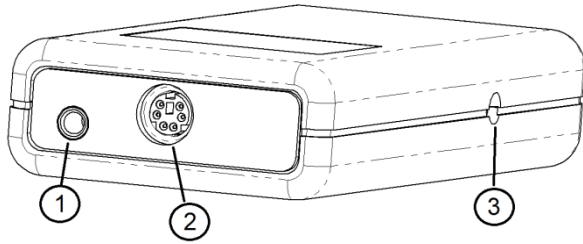

- 1. Output:** Operation as interface for the connection of galvanically isolated adapters (accessories: GRS 3100, USB 3100)

Attention: The mode of operation has to be configured (p.r.t Chapter 5) and influences the power consumption.

- 2. Sensor connection** MiniDIN
- 3. Power supply:** d.c.connector (internal pin Ø 1.9 mm) for external 10.5-12V direct voltage supply

### 4.5 Display elements

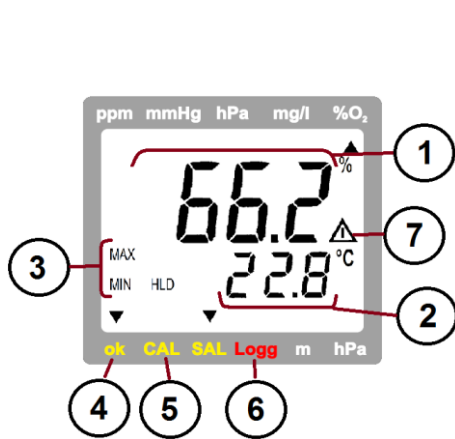

- 1 = Main Display:** Display of the oxygen value, please refer to chapter 5, [h 2] (change with -key)
- 2 = secondary display:** Display of sensor temperature or absolute pressure (alternating, please refer to Chapter 5. Lcd.2)
- Special elements:**
- 3 = MIN/MAX/HLD:** Shows, if minimum/maximum/memorized measuring value is in display
- 4 = ok-arrow:** Signals, if oxygen and temperature values are stable
- 5 = CAL- arrow:** Signals, if automatic calibration is in progress
- 6 = Logg - arrow** No function
- 7 = Warning sign:** Signals weak battery or other warning message

Die restlichen Pfeile haben in dieser Gerätevariante keine Funktion

### 4.6 Pushbuttons



**On / off key**

**Set/Menü**

Press 2 sec.: (Menu): call configuration menu  
Press shortly: Change the oxygen display unit (please refer to chapter 5)

**min/max when taking measurements:**

press shortly: min. or max. measured oxygen value and referring temperature and pressure values will be displayed

press for 2 sec.: the min. or max. value will be deleted

**Configuration:** to enter values, or change settings



**Store/Enter**

- Measuring: with Auto-Hold off: hold and save current measuring value ('HLD' is displayed) with Auto-Hold on: start new measuring, It is finished, when "HLD" shows in display
- Set/Menu: confirm settings, return to measuring



**CAL:**

- press shortly: display of sensor state rating
- press for 2 sec: start sensor calibration

## 4.7 Pop-up clip

### Handling:

- Pull at label “open” in order to swing open the pop-up clip.
- Pull at label “open” again to swing open the pop-up clip further.

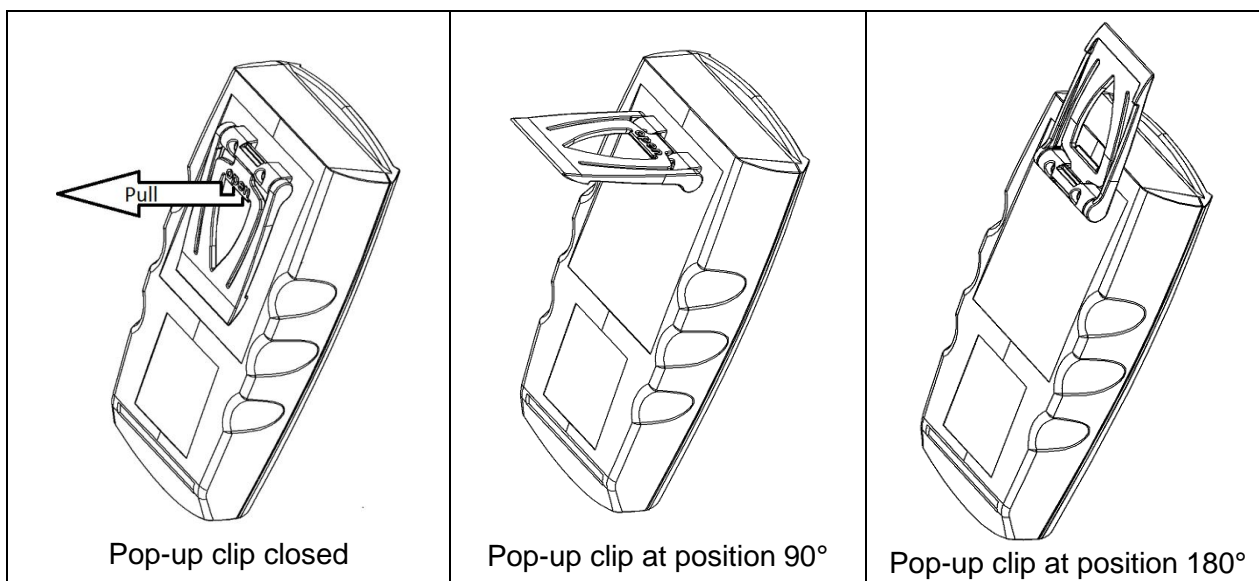

### Function:



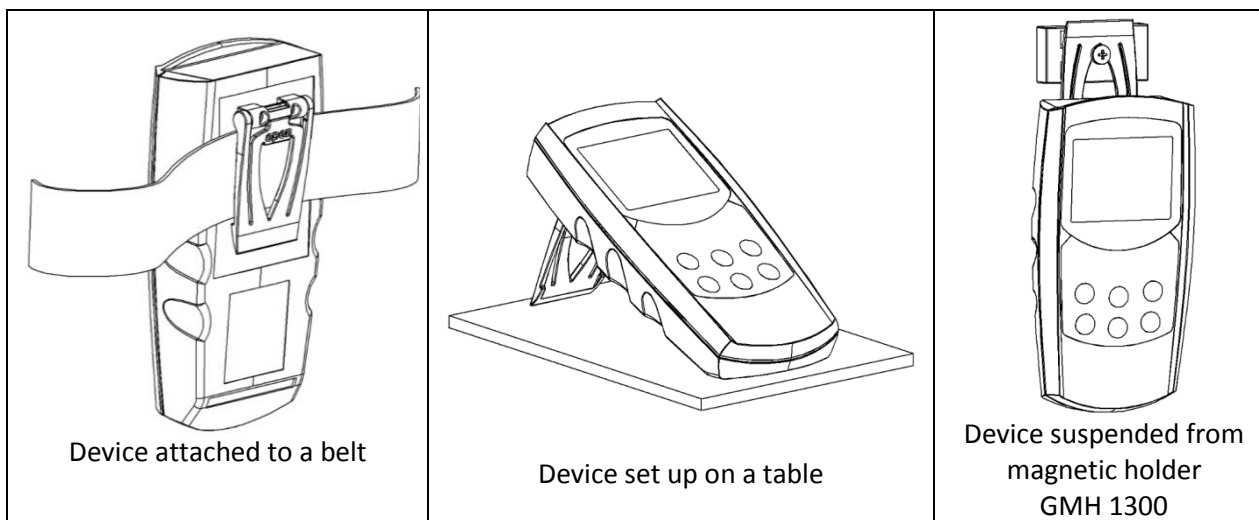

- The device with a closed pop-up clip can be plainly laid onto a table or attached to a belt, etc.
- The device with pop-up clip at position 90° can be set up on a table, etc.
- The device with pop-up clip at position 180° can be suspended from a screw or the magnetic holder GMH 1300.







## 5 Configuration



Some menu points depend on current device settings.

To change device settings, press „Menu“  for 2 seconds. This will activate the configuration menu (main display: “Set”). Pressing „Menu“  changes between the menus points, pressing  jumps to the referring parameters, which can be selected with key .

The parameters can be changed with  or . Pressing „Menu“  again jumps back to the main configuration menu and saves the settings. "Quit"  finishes the configuration and returns to standard measuring operation.

Menu	Parameter	Value	Description	
key Menu	key ▶	key ▲ or ▼		p.r.t
<b>Set Configuration: General configurations</b>				
SEt Conf	Unit Conc	Conc ppm	Display unit of O <sub>2</sub> -concentration ppm (identical values like mg/l)	*
		Conc mg/l	Display unit of O <sub>2</sub> -concentration mg/l (identical values like ppm)	
	Ch 2	SAt %O <sub>2</sub>	Main display shows O <sub>2</sub> -concentration (mg/l or ppm) or O <sub>2</sub> -Saturation in % (ex works setting)	
		P O <sub>2</sub> hPa	Main display shows O <sub>2</sub> -concentration or O <sub>2</sub> -partial pressure in hPa	
		P O <sub>2</sub> mmHg	Main display shows O <sub>2</sub> -concentration or O <sub>2</sub> -partial pressure in mmHg	
	RES	H <sub>1</sub>	Best O <sub>2</sub> resolutions	
		L <sub>0</sub>	Low O <sub>2</sub> resolution, calm value display (standard)	
	SAL	oFF	Salinity correction deactivated (ex works setting)	
		0.1 ... 70.0	Salinity correction activated, Unit ‰ = PSU	
	Lcd.2	t	Second. display always temperature	
		P	Second. display always absolute pressure	
		P t	Second. display alternates between temperature and abs. pressure	
	Unit t	°C	All temperatures in degree Celsius (ex works setting)	
		°F	All temperatures in degree Fahrenheit	
	C. Int	1 ... 365	Calibration reminder period (in days)	
		oFF	No calibration reminder	
	Auto HLD	on	Auto measuring value identification Auto Hold (when logger = off)	
		oFF	Standard hold function on key press (when logger = off)	
P.oFF	1 ... 120	Power-off delay in minutes. Device will be automatically switched off as soon as this time has elapsed if no key is pressed/no interface communication takes place. (ex works setting 20min)		
	oFF	Automatic power-off function deactivated (continuous operation)		
Adr	01, 11, 21, ... 91	Base address for serial interface communication (ex works setting 01)		
<b>Set Corr: Input adjustment</b>				
SEt Corr	OFFS °C or °F	-5.0 °C .. 5.0 °C or -9.0 °F .. 9.0 °F	The zero point of the temperature measuring is shifted for the entered value. This can be used to compensate sensor and instrument deviations	
		oFF	No zero adjustment for temperature measurement (=0.0°)	
		oFF	No zero adjustment for temperature measurement (=0.0°)	
SCAL °C or °F	-5.00 ... 5.00 %	The slope of the temperature measurement is corrected by this value. This can be used to compensate sensor and instrument deviations		
	oFF	No slope adjustment for temperature measurement (=0.00)		
OFFS hPa	-20 .. 20 hPa	The zero point of the pressure measuring is shifted for the entered value. This can be used to compensate sensor deviations		
	oFF	No zero adjustment for pressure measurement (=0.0°)		



**Pressing “menu” and “store” at the same time for more than 2 seconds will reset the device to factory defaults**

If no key is pressed for more than 2 minutes the configuration will be aborted.

All changes will not be saved!

## 6 The Oxygen Sensor

### 6.1 Design of Sensor GWO 3600

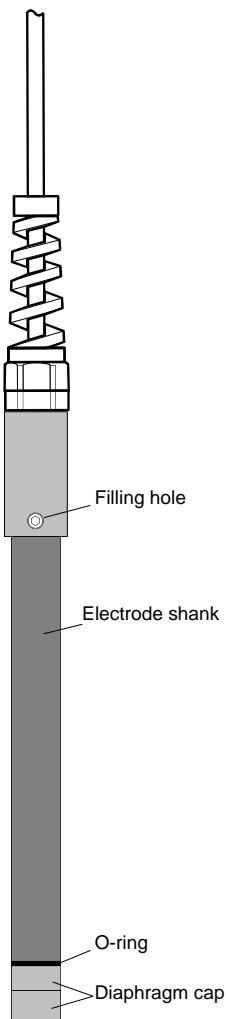

#### General information

The oxygen electrode is an active electrode consisting of a silver cathode and a lead anode with the electrolyte being potassium hydroxide (KOH). In case of oxygen being present it will be reduced at the silver cathode, i.e. the electrode supplies a current. No oxygen means no current either. The oxygen measurements use up both the silver cathode as well as the lead anode. The electrode is subject to ageing. Therefore, we recommend to maintain the electrode at monthly intervals (p.r.t. 'Electrode maintenance')

Please note: Make it a rule to always store the electrode in a humid environment.



- in the storage flask filled with water
- in another container filled with water

If electrode has not been used for some time, clean diaphragm with soft cloth and remove deposits, if any (algae, bacteria etc.).

#### Electrode design

The electrode housing is made of PVC. With the exception of the electrode shaft all parts need to be maintained regularly and be replaced if necessary.

- o **Protective flask:** The protective flask is used to moisten the diaphragm. This prolongs service life of the electrode. The protective flask contains water. Attention! Use water only; never use potassium chloride (KCl); this is only required for storage of pH-electrode.
- o **Diaphragm head:** the diaphragm head is covered with a teflon diaphragm. It will be filled with KOH electrolyte and screwed onto the electrode shaft (no air bubbles). Damages in the diaphragm, large air bubbles or air bubble rings in the diaphragm head will result in erroneous measurements. This may also be the reason for errors in the calibration. The diaphragm head is a spare part and can be ordered individually.
- o **Filling hole:** If the electrode is used at high temperatures or if it has been stored without its protective flask for a longer period of time, some electrolyte will be lost due to evaporation. During maintenance make it a rule to unscrew diaphragm head, remove locking screws and top up electrolyte using a syringe. Replace and tighten locking screws.

**Attention when working with electrolyte! The electrolyte is corrosive! (strong base, KOH)**



DANGER

### 6.2 Electrode Maintenance

If electrode can no longer be calibrated, it needs maintenance.

**Attention! The electrolyte is a corrosive.**

To maintain electrode please proceed as follows:

1. Unscrew diaphragm head and wipe clean of electrolyte solution using a paper cloth. Do not touch electrolyte. If your skin had contact with electrolyte, immediately rinse thoroughly with clear water.
2. Clean silver cathode with sand paper (grain size 240). Do not polish silver cathode, surface should stay rough. Remove all dust.
3. Remove filling screw and top up lost electrolyte (e.g. using disposable syringe)
4. Put back and tighten filling screw.
5. Top up diaphragm head with electrolyte avoiding air bubbles and place on table (cover table with absorbent paper first).
6. Keep electrode in a vertical position and screw diaphragm head to the electrode from the bottom. Electrolyte will be forced out of the diaphragm head and spill over (put on disposable gloves or use paper towel to touch diaphragm head).
7. Wipe up excess electrolyte with paper cloth.
8. Check cathode for air bubbles.

If there are large air bubbles, remove diaphragm head again and repeat process as of point 5. If O-ring has been damaged, it has to be replaced.

When maintenance has been completed plug on protective flask. Re-connect electrode to measuring device and wait for at least 3 hours till electrode can be calibrated.



## 7 Oxygen Measuring - please note

Please observe the following points when measuring dissolved oxygen:

- **For measuring remove the protective flask.**

- **Do not disconnect electrode from device.**

If electrode has been disconnected, wait 2 - 3 hours till the final electrode signal has settled before carrying out measurements or a calibration.

- **Electrode needs to be calibrated** (p.r.t. 'How to calibrate oxygen electrode')

- **The temperatures of the electrode and of the liquid to be measured have to be identical** (if necessary, wait till temperatures match)

- **The Electrode has to be submerged at least 3 cm into the liquid to be measured**

- **The measured liquid has to stream along the electrode membrane with at least 30 cm/sec** for measurements to be sufficiently accurate: either stir continuously or use agitator.

- The electrode measurement is sensitive against shocks!

By stirring of the electrode in the measured liquid be careful that the electrode does not hit the container. A vibration of the electrode has an effect to the measured value.

-The **optimum operation position** is: with the sensor inlet pointing downwards

The instrument calculates the oxygen concentration [mg/l], the oxygen saturation [%] and the oxygen partial pressure [hPa] from the electrode signal and the temperature. According to DIN38408-C22 all measurements refer to steam saturated air.

### 7.1 Ambient pressure and measuring depth of the electrode

The pressure at the sensor membrane is important for:

- The calculation of the oxygen saturation (%sat).

At air water can get 100% saturation. Assumed that there are no oxygen consuming processes (biological degradation, chemical effects) and that there are no oxygen enriching processes (e.g. excessive ventilation or photosynthesis)

- The calculation of oxygen concentration (mg/l or ppm)

- The electrode evaluation at calibration

Therefore it is necessary to compensate the pressure influence via integrated sensor or, like practised with more primitive instruments via tables and manual input of pressure or Elevation above sea level values.

### 7.2 Correction of salinity ('SAL')

The higher the salinity (salt content) the lower the solubility of oxygen in water, i.e. although the partial oxygen pressure is the same, the quantity of oxygen dissolved in water (mg/l) is lower. Therefore, determination of the oxygen concentration requires entering the salinity of the medium (p.r.t. 'Configuration'). The correction of salinity is based on media on a water basis, whose chemical content is similar to sea water. The corrections are based on the 'International Oceanographic Tables' (IOT).

## 8 Calibration of the Sensor

In order to compensate for ageing of the sensor, the sensor has to be calibrated at regular intervals.

The device is equipped with a easy-to-use calibration function.

We recommend to calibrate the sensor at least all 7 days, or to get maximum precision, before each measuring series.

If the electrode was dry for one or more days it has to be 'watered' for at least 30 minutes before carrying out a new calibration.

### 8.1 How to Calibrate

The calibration adjusts the sensor to the oxygen content of the atmosphere (20.95%). Remove protective flask prior to calibration and wipe diaphragm with a soft piece of cloth. You can choose between three modes of calibration for which the electrode has to be prepared accordingly.

**Air calibration without accessories ('Cal Air')**

The electrode will be exposed to **ambient air**. To protect it from draughts, wrap electrode in a paper towel. (before calibration, expose sensor at least 15 minutes to the ambient air, to let the temperature adjust and to dry membrane)

Depending on the rel. atmospheric humidity [%] and the temperature [°C] a small calibration error cannot be avoided and will have to be accepted. The cooler the air is, the smaller the deviation.

Recommended temperature: < 25°C.

For error compensation please refer to the opposite table.

Note: A correctly calibrated electrode shows 106 - 108% at air and at room temperature.

	20%	40%	60%	80%	100%
5 °C	1.007	1.005	1.003	1.002	1.00
10 °C	1.01	1.007	1.005	1.002	1.00
15 °C	1.014	1.01	1.007	1.003	1.00
20 °C	1.019	1.014	1.009	1.005	1.00
25 °C	1.026	1.019	1.013	1.006	1.00
30 °C	1.035	1.026	1.017	1.009	1.00
35 °C	1.047	1.035	1.023	1.012	1.00
40 °C	1.063	1.047	1.031	1.016	1.00

*Deviations when carrying out an air calibration without accessories,  
O<sub>2</sub>-saturation= display value\*corr. factor*

**Air calibration for highly accurate measurements ('Cal Air')**

The electrode is exposed to **air with a relative atmospheric humidity of 100%**.

Proceed as follows: Put some distilled water in a bottle. Close bottle and generate a water steam saturation (100% rel. atmospheric humidity) in the remaining air by shaking it vigorously for approx. 3 minutes. Both water and air temperatures should be identical. Open bottle and insert electrode so that the diaphragm is in the air chamber.

**Attention:** By no means must the diaphragm get wet or be immersed in water. The bottle neck opening should only be slightly larger than the electrode diameter; make sure to avoid over pressure in the container.

Note: A correctly calibrated electrode shows 106 - 108% at air and at room temperature.

**Calibration in air saturated water (configuration: 'Cal AqUA')**

This mode of calibration is more difficult than the ones already described. As water is easily oversaturated it quickly results in calibration errors. In order to generate air saturated water, pure water (25-30°C) is poured into another container from a height of 50 cm. This process is repeated 20 times. In order to let an oversaturation evaporate, wait approx. 5 min. before carrying out the calibration (do not forget to stir).

**Start calibration: press -key for 2 seconds**

The display will show 'R, r PL IS' and as soon the values for oxygen and temperature are stable, the calibration will be finished.

Then the electrode state resulting of the successful calibration will be shown for a short time (evaluation in 10% steps: xx% ELEC).



In case of error messages being displayed during the calibration process, please refer to our notes at the end of this manual! If a calibration cannot be carried out after an extended period of time, at least one of the measuring values is unstable (oxygen partial pressure, temperature).

Please check your measuring arrangements!

**8.2 Evaluation of Sensor State (ELEC)**

Watch sensor state: press key "CAL" shortly oncedisplay show for a short time xx% ELEC.

It will show the electrode state resulting of the last successful calibration carried out.

The valuation is displayed in 10 percent steps: 100% means optimal sensor condition. Lower values are indicating that the sensor life time will be reached soon.

*Remark: But also a erroneous pressure may be the cause of low valuation values.*

**8.3 Calibration Interval (Int)**

You can enter the interval after which the device reminds you to recalibrate in the configuration.

The interval times should be chosen according to the application and the stability of the sensor.

"CAL" flashes on the display as soon as the interval has expired.

## 9 Inspection of the accuracy / Adjustment Services

The instrument can be sent to the manufacturer for adjustment and function test. Only the manufacturer can check all systems on correct them if necessary.

Calibration certificates – DKD-certificates – other certificates:

If device should be certificated for its accuracy, this is not possible for dissolved oxygen measuring, only for abs. Pressure and temperature.

## 10 Serial Interface

With an electrically isolated interface converter USB3100, GRS3100 or GRS3105 (accessory) the device can be connected to a PC.

With the GRS3105 it is possible to connect up to 5 instruments of the GMH3000 family to a single interface (please also refer to GRS3105-manual). As a precondition the base addresses of all devices must not be identical, make sure to configure the base addresses accordingly (refer menu point "Adr." in chapter 5). In order to avoid transmission errors, there are several security checks implemented (e.g. CRC).

The following standard software packages are available for data transfer:

- **GSOFT3050:** Operating and evaluation software for instruments with integrated logger function
- **EBS20M/ -60M:** 20- / 60-channel software to record and display the measuring values
- **GMHKonfig:** Software for a comfortable configuration of the device (e.g. freeware)

In case you want to develop your own software we offer a **GMH3000-development package** including

- an universally applicable 32bit Windows functions library ('GMH3000.DLL') with documentation that can be used by all 'serious' programming languages.
- Programming examples for Visual Studio 2010 (C#, C++), Visual Basic 6.0™, Delphi 1.0™, Testpoint™, Labview™

**The Device has 4 Channels:**

- oxygen concentration in mg/l or ppm
- oxygen saturation in percent or partial pressure in hPa or mmHg
- temperature value at the time of recording in °C or °F
- absolute pressure in hPa abs or mmHg abs or depth in m





**Supported Interface-functions:**

1	2	3	4	Code	Name/Function	1	2	3	4	Code	Name/Function
x	x	x	x	0	read nominal value	x	x	x	x	199	read measuring type in display
x	x	x	x	3	read system status	x	x	x	x	200	read min. display range
x				12	read ID-no.	x	x	x	x	201	read max. display range
x	x	x		22	read min alarm limit	x	x	x	x	202	read unit of display
x	x	x		23	read max alarm limit	x	x	x	x	204	read decimal point of display
						x				208	read channel count
						x				222	read turn-off-delay
x	x	x	x	178	read measuring range unit	x				223	Set turn-off-delay
x	x	x	x	179	read measuring range decimal point	x				240	Reset
x	x	x	x	180	read measuring type	x				254	read program identification

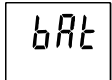

***The measuring and range values read via interface are always in the selected display unit!***

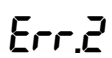





## 11 Error and System Messages

Display	Meaning	Remedy
	low battery voltage, device will continue to work for a short time	replace battery
	If mains operation: wrong voltage	replace power supply, if fault continues to exist: device damaged
	low battery voltage	replace battery
	If mains operation: wrong voltage	Check/replace power supply, if fault continues to exist: device damaged
No display or weird display  Device does not react on keys	low battery voltage	replace battery
	If mains operation: wrong voltage	check/replace power supply, if fault continues to exist: device damaged
	system error	disconnect battery or power supply, wait some time, re-connect
	device defective	return to manufacturer for repair
	sensor error: no sensor cable connected	connect suitable sensor
	Sensor, cable or instrument defect	return to manufacturer for repair
	Value exceeding measuring range	Check: Is the value exceeding the measuring range specified? ->value too high!
	Wrong sensor connected	Check sensor
	Sensor, cable or instrument defect	return to manufacturer for repair
	Value below display range	Check: Is the value below the measuring range specified? ->value too low!
	Wrong sensor connected	Check sensor
	Sensor, cable or instrument defect	return to manufacturer for repair
	system error	return to manufacturer for repair

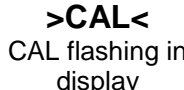
If **"bat"** is flashing, the battery will be exhausted soon. Further measurements are possible for short time.

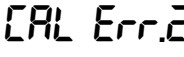
If **"bat"** is displayed continuously the battery is ultimately exhausted and has to be replaced. Further measurements aren't possible any more.

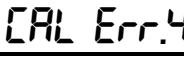
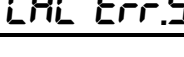
### Messages During Calibration/Adjustment

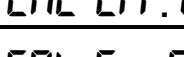
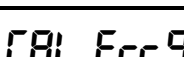
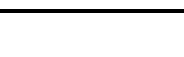
	either preset calibration interval has expired or last calibration is not valid	Device has to be calibrated!
	wrong reference point at air	check sensor and reference gas / solution
	slope too low	
	reference gas / solution wrong sensor is defect	check sensor and reference gas / solution replace sensor / perform maintenance
	slope too high	
	reference gas / solution wrong sensor is defect	check sensor and reference gas / solution replace sensor / perform maintenance
	incorrect calibration temperature	calibration can only be done at 0...40 °C
	Zero value to low/negative	
	sensor is defect	replace sensor / perform maintenance
	zero value to high	
	reference gas / solution wrong sensor is defect	check sensor and reference gas / solution replace sensor / perform maintenance
	incorrect calibration pressure	check calibration pressure
	signal not stable / timeout	check sensor and reference gas / solution
	sensor not known: cannot be calibrated	check sensor and wiring

## 12 Specification

Measuring ranges	Oxygen concentration	0.00 ... 70.00 mg/l or ppm	electrochemical sensor GWO 3600
	Oxygen saturation	0.0 ... 600.0 % O <sub>2</sub>	
	Oxygen partial pressure	0 ... 1200 hPa O <sub>2</sub> (0.0 .. 427.5 mmHg) <sup>4</sup>	
	Sensor temperature	-5.0 ... + 50.0 °C	NTC 10k (integrated in GWO 3600)
	Absolute pressure	10 ... 1200 hPa abs.	integrated pressure sensor
Accuracy at 25°C, 1000 hPa abs	Oxygen	±1.5 % of measured value ±0,2 mg/l (0-25 mg/l) or ±2.5 % of measured value ±0,3 mg/l (25-70 mg/l)	
	Sensor temperature	± 0.1 °C	
Accuracy	Absolute pressure	3 hPa or 0.1% of measured value (the higher one to be applied)	
Working conditions	-20 ... 50 °C; 0 ... 95 % r.H. (not condensing)		
Nom. temperature	25°C		
Storage temp.	-20 ... 70 °C		
Connections	O <sub>2</sub> & temperature	6 pole Mini-DIN Socket	
	Interface /	serial, (3.5mm audio plug), via isolated adapter GRS3100, GRS3105 or USB3100 (accessories) for PC-USB or RS232- connection	
	external supply	d.c. connector (diameter of internal pin 1.9 mm) for external 10.5-12V direct voltage supply. (suitable power supply: GNG10/3000)	
Oxygen sensor GWO 3600	Working conditions	0 ... 40 °C	
	Operating pressure	max. 3 bar	
Display	4 digit 7-segment 2 lines, additional segments		
Calibration	automatic	1 -point calibration, at ambient air (20.95%)	
GLP	adjustable calibration intervals (1 to 365 days, CAL warning after expiration)		
Additional functions	Min / max / hold / auto hold		
Housing	Break-proof ABS housing		
	Protection class	Front side IP65	
	Dimensions L*B*H [mm]	142 x 71 x 26 mm (L x B x H)	
	Weight	approx 160 g (incl. battery)	
Power supply	9V-Battery, Type IEC 6F22 (in scope of supply) or external supply		
Current consumption	Ca. 0.6 mA (if Out = Off ca. 0.4mA)		
Change battery indicator	Automatic at weak battery  and ' bAt '		
Auto-Off-Function	Device will be automatically switched off if no key is pressed/no interface communication takes place for the time of the power-off delay. The power-off delay can be set to values between 1 and 120 min.; it can be completely deactivated.		
EMI	The device corresponds to the essential protection ratings established in the Regulations of the Council for the Approximation of Legislation for the member countries regarding electromagnetic compatibility (2004/108/EG). Additional fault: <1%		

## 13 Reshipment and Disposal



Dispense exhausted batteries at destined gathering places.  
This device must not be disposed as "residual waste". To dispose this device, please send it directly to us (adequately stamped). We will dispose it appropriately and environmentally friendly.



All devices returned to the manufacturer have to be free of any residual of measuring media and other hazardous substances. Measuring residuals at housing or sensor may be a risk for persons or environment



Use an adequate transport package for reshipment, especially for fully functional devices. Please make sure that the device is protected in the package by enough packing materials.

