

Flow transmitter OMNI-RRI-032RMH



- Flow transmitter with display
- for pipe diameters of DN32 or larger
- Plastic version
- Suitable for retrofitting in existing pipelines with tapping clamps
- Analog output 4..20 mA or 0..10 V
- Two programmable switches
- Selectable units in the display
- Parameter change via rotating ring
- Electronics housing with non-scratch, chemically resistant glass
- Rotatable electronic housing for best reading position

Features

The OMNI transducer located on the sensor has a backlit graphics LCD display which is very easy to read, both in the dark and in bright sunlight. The graphics display allows the presentation of measured values and parameters in a clearly understandable form. The measured values are displayed to 4 places, together with their physical unit, which may also be modified by the user. The electronics have an analog output and two limit switches. Exceeding limit values is signalled by a red LED which is visible over a long distance, and by a message in text in the display.

The stainless steel housing has a hardened non-scratch mineral glass pane. It is operated by a programming ring fitted with a magnet, so there is no need to open the operating controls housing, and its tight seal is permanently ensured.

By turning the ring to right or left, it is simple to modify the parameters.

A preset counter (option C) enables totalisation of the flow rate quantity and signal output when the preset quantity is reached. It also offers an external reset option, antivalent switching outputs and a current value display.

A totaliser with pulse output (option C1) issues a pulse cyclically after a variable amount has flown. The current flow rate is shown in the display and on the analog output.

Technical data

Measuring principle	Paddle wheel	
Nominal widths	DN32 and larger	
Mechanical Connection	Insertion probe with union nut (welded-on nozzle and tapping clamps available as accessories)	
Measuring range	0.3...6 m/s	
Reproducibility	± 1 %	
Media temperature	0 – +60 °C	
Pressure resistance	PN 10	
Wetted materials	Housing Rotor Bearing Axis Seals	PVC PVDF / 1.4310 (titanium available on request) Iglidur X Ceramics ZrO ₂ -TZP Fluororubber FKM
Other materials	Electronics housing Glass Magnet Ring	Stainless steel 1.4305 Mineral glass, hardened Samarium Cobalt POM
Power supply	18..30 V DC	
Power requirement	< 2 W (for outputs not under load)	
Analog output	4..20 mA / max. load 500 Ω or 0..10 V / min. load 1 kΩ	
Switching output	Transistor output "push-pull" (resistant to short circuits and reversed polarity) I _{out} = 100 mA max.	
Hysteresis	adjustable, position of the hysteresis depends on minimum or maximum	
Display	graphic LCD display, extended temperature range -20..+70 °C, 32 x 16 pixels, background illumination, displays value and unit, flashing LED signal lamp with simultaneous message on the display	
Electrical connection	for round plug connector M12x1, 5-pole	
Protection rating	IP 67 / (IP 68 when oil-filled)	
Conformity	CE	
Weight	approx. 0.38 kg (incl. clamping ring and union nut)	

Dimensions

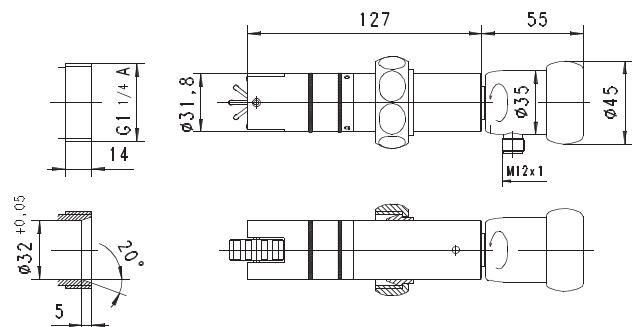

Gooseneck option



A gooseneck (option H) between the electronics head and the primary sensor provides freedom in the orientation of the sensor.

Ranges

The measuring range of the flow transmitter is 0.3 ... 6 m/s. The result is approximate flow rates in pipes of various nominal widths according to the following table (not considering the flow profile).

DN	Measuring range	
	l/min	m³/h
32	15... 300	18
40	23... 460	27
50	35... 700	42
65	60...1200	72
80	90...1800	108
100	140...2800	168
125	220...4400	264
150	315...6300	378

On request, the flow rate (in "l/min" or "m³/h", switchable on the device) can be displayed instead of the flow speed. For this purpose, specification of the inside pipe diameter is necessary when placing an order. If the inside pipe diameter is known, options C or C1 can also be selected, which enable counting and display of flow quantities.

Signal output characteristic curves

Value x = beginning of the specified metering range
 = not specified range

Current output

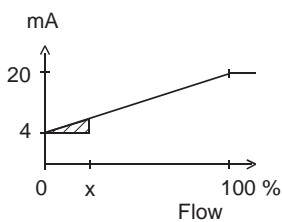

Voltage output

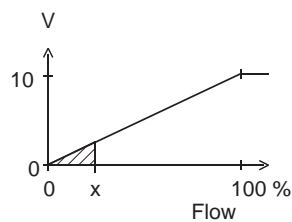

Connection diagram

The switching outputs are designed as push-pull drivers, and can therefore be used both as PNP and NPN outputs.

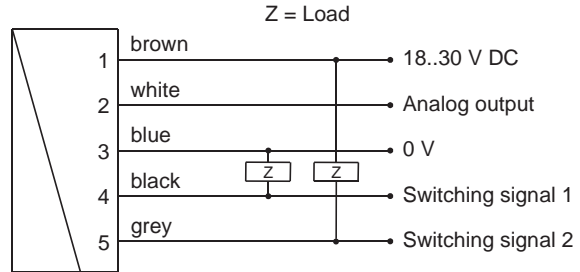

Connection example: PNP NPN

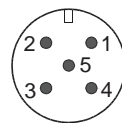

Plug connector M12x1 (view of connector plug)

See separate connection diagram of option C in the corresponding description.

Handling and operation

Assembly

The sensor should be installed with run-in and run-out sections of 10 x D of the pipe diameter, in order to minimise the influence of vortices and turbulence.

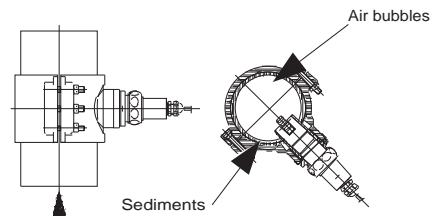

The best installation position (low contamination, good venting) is with the direction of flow from bottom to top, or in horizontal piping with the sensor at an angle of 45° downwards. The union nut must be tightened to a torque of 30 Nm.

Installation method:

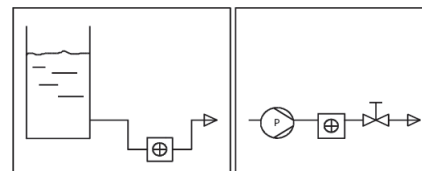

Rotor always under liquid

Rotor upstream from valve

Operation

Parameter change

The annular gap of the programming ring can be turned to positions 1 and 2 and thus replaces the function of two buttons



The following parameters can be changed in this manner:

- Switching values (in the display unit)
- Switching characteristics
MIN = Monitoring of minimum value
MAX = Monitoring of maximum value
- Hystereses (in the display unit)

After entering a code, further parameters can be adjusted:

- Filter (settling time of the display and output)
- Display unit (m/s; %; l/min; m³/h)
- Output: 0 or 4...20 mA and/or 0 or 2...10 V
- Scaling of the output

Operation is by dialogue with the display messages, which makes its use very simple. The ring can be removed to act as a key, or turned 180° and returned to create a programming protector.



Alarm signal

If the adjusted switching values are exceeded or undercut, an alarm is indicated by the integrated red LED and a message in text in the display.

Overload display

The overload of a switching output is signalled by a display message and the blinking red LED. The relevant switching output is switched off and switched on again automatically after the fault has been rectified.

Simulation mode

To simplify commissioning, the sensor provides a simulation mode for the analog output. It is possible to create a programmable value in the range 0...21.0 mA and/or 0...10 V at the output (without modifying the process variable). This allows the wiring run between the sensor and the downstream electronics to be tested during commissioning.

Ordering code

OMNI-RRI-032RMH 1. 2. 3. 4.

1. Analog output			
I	Current output 0/4..20 mA		●
U	Voltage output 0/2..10 V		●
K	without		●
2. Electrical connection			
S	For round plug connector M12x1, 5-pin		
3. Options 1			
H	Gooseneck model		
O	Tropical version, oil-filled version		
4. Options 2			
C	Counter C		
C1	Counter C1		

Options

- Counter C (hardware and software option):
Preset counter with external resetting option, antivalent switching outputs and current value display (modified wiring!)
- Counter C1 (software option):
Current value display with analog output, volume pulse output and totaliser

See separate information for counter option C and C1.

- The housing is filled with out in the **tropical version** and thereby safely prevents the penetration of moisture under extreme climatic conditions.
- Additional special versions available on request

Accessories

- Round plug connector KB05 / cable K05PU
- Weld-on nozzle VKI-032K
- Tapping clamps BBI-032H
- Measuring tubes MH-032H
- Device configurator ECI-3