

## Flow Switch HD1F



- High switching power
- Compact design

### Characteristics

Mechanical flow switch, for fluid or gaseous media, with spring-supported piston and magnetic triggering of a reed switch. Robust construction in brass or stainless steel.

### Technical data

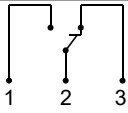
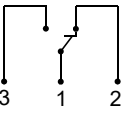
<b>Switch</b>	reed switch	
<b>Nominal width</b>	DN 8..25	
<b>Process connection</b>	female thread G 1/4..G 1 (further process connections available on request)	
<b>Switching range</b>	0.1..80 l/min	for details see table "Ranges"
<b>Pressure loss</b>	0.4..1.6 bar at Q <sub>max.</sub>	
<b>Q<sub>max.</sub></b>	to 100 l/min	
<b>Tolerance</b>	±5 % of full scale value	
<b>Pressure resistance</b>	PN 200 bar optionally PN 500 bar	
<b>Media temperature</b>	-20..+120 °C with display Z -20..+70 °C optionally -20..+150 °C	
<b>Ambient temperature</b>	-20..+70 °C	
<b>Media</b>	water, oil (gases and aggressive media available on request)	
<b>Wiring</b>	changeover No. 0.213  optionally changeover No. 0.282  optionally red or red / green diode in the plug DIN 43650-A / ISO 4400	
<b>Electrical data (without EX)</b>	175 V DC, 0.25 A, 5 W / 120 V AC, 0.18 A, 5 VA	
<b>Electrical data (with EX)</b>	250 V AC, 1.5 A, 50 VA	
<b>Electrical data (optional)</b>	normally open contact, 250 V DC, 1.5 A, 50 W / 265 V AC, 1.1 A, 50 VA	
<b>Protection class</b>	2 - safety insulation	
<b>Ingress protection</b>	IP 65	
<b>Electrical connection</b>	plug DIN 43650-A / ISO 4400 optionally for round plug connector M12x1, 4-pole	

<b>Materials medium-contact</b>	<i>Brass construction:</i> CW614N nickelled, CW614N, 1.4310, hard ferrite, NBR	<i>Stainless steel construction:</i> 1.4571, 1.4404, 1.4310, hard ferrite PTFE-coated, FKM
<b>Non-medium-contact materials</b>	PA, CW614N, NBR	
<b>Weight</b>	see table "Dimensions and weights"	
<b>Installation location</b>	Standard: horizontal inwards flow from the left; other installation positions are possible; the installation position affects the switching point and range.	

### Ranges

For switching ranges, the details in the table correspond to horizontal inwards flow and decreasing flow rate; for display ranges they correspond to horizontal inwards flow and increasing flow rate.

### Standard type HD1F

Switching range l/min H <sub>2</sub> O	optionally Display range l/min H <sub>2</sub> O	Q <sub>max.</sub> recommen- ded	Pressure loss bar at Q <sub>max.</sub> H <sub>2</sub> O
0.1 - 1.0	0.1 - 1.2	6	0.4
0.5 - 5.0	0.5 - 6.0	10	0.5
1.0 - 10.0	1.0 - 12.0	20	0.6
2.0 - 20.0	2.0 - 23.0	30	0.4
3.0 - 30.0	3.0 - 34.0	40	
4.0 - 40.0	4.0 - 45.0	60	0.8
6.0 - 60.0	6.0 - 65.0	80	1.4
20.0 - 80.0	20.0 - 85.0	100	1.6

Special ranges are available.

### Dimensions and weights

	G	Types	SW	X	Weight kg
Brass	G 1/4	HD.F-008GM	40	15	1.4
	G 3/8	HD.F-010GM			
	G 1/2	HD.F-015GM		18	1.3
	G 3/4	HD.F-020GM			
	G 1	HD.F-025GM			
Stainless steel	G 1/4	HD.F-008GK	41	15	1.3
	G 3/8	HD.F-010GK			
	G 1/2	HD.F-015GK			
	G 3/4	HD.F-020GK		18	1.2
	G 1	HD.F-025GK			
	G 1	HD.F-025GK			

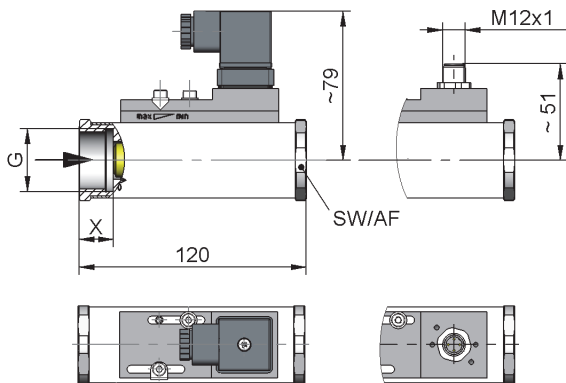

### additional weights for options

additional switching head 0.10 kg    Display O / Z 0.10 kg  
 Display O1 / Z1                    0.05 kg

### Handling and operation

#### Note

- Include straight calming section of 5 x DN in inlet and outlet
- If the media are dirty, install a filter (use magnetic filter for ferritic components).
- It must be ensured that the values given for voltage, current, and power are not exceeded.
- When switch on, a load must be connected in series.
- The electrical details apply to ohmic loads. Capacitive, inductive and lamp loads must be operated using a protective circuit.

#### Adjustment

If it is necessary to set the switching value, the switching head can be adjusted lengthways. When the switching value is reached, the switching unit is fixed in place by fastening bolts.



### Ordering code

HD1F    1.    2.    3.    4.    5.    6.

HD1F             G           

1. Display options	
-	no mechanical display
O1-	with measurement display at side O1
O-	with measurement display at side O
Z1-	with frontal measurement display Z1
Z-	with frontal measurement display Z
2. Nominal width	
008	DN 8 - G 1/4
010	DN 10 - G 3/8
015	DN 15 - G 1/2
020	DN 20 - G 3/4
025	DN 25 - G 1
3. Process connection	
G	female thread
4. Connection material	
M	brass
K	stainless steel
5. HD1F - switching range H <sub>2</sub> O for horizontal inwards flow	
001	0.1 - 1 l/min
005	0.5 - 5 l/min
010	1.0 - 10 l/min
020	2.0 - 20 l/min
030	3.0 - 30 l/min
040	4.0 - 40 l/min
060	6.0 - 60 l/min
080	20.0 - 80 l/min
6. Special switching head	
A	switching head ATEX A-H4.1 / A-H4.2 Please order the switching head for  -use in addition.

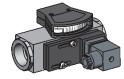

HD.FO1-

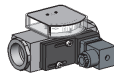

HD.FO-

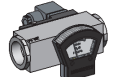

HD.FZ1-

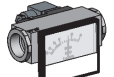

HD.KZ-

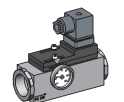

Temperature-display

### Options

- Signal lamp red or red / green in the plug DIN 43650-A
- Rhodium contact (250 VAC, 0,5 A, 30 VA)
- SPST N.O.: 250 V DC; 1.5 A; 50 W / 265 V AC; 1.1 A; 50 VA
- Temperature resistant up to 150 °C
- Reinforced piston (only if made of brass)
- Additional switching head
- Connection for round plug connector M12x1
- High pressure model PN 500 (only if made of brass)
- Switching values for oil or gas
- Special values
- Temperature display 0..120 °C
- Shock proof with increased switch hysteresis 250 V AC; 1.5 A; 50 VA

### Ordering information

- Specify direction of flow, medium, and switching range.
- For viscous media specify viscosity, temperature, and medium (e.g. ISO VG 68) (enquire about switching range).
- For gases, state pressure (relative or absolute), temperature and medium (e.g. air) (request switching range).