

Flow Meter / Monitor FLEX-HD2K



- viscosity stabilized
- 4..20 mA or 0..10 V output signal
- 1 x programmable switch or frequency output
- Programmable switching value, full scale, or zero point via magnet clip
- Programming protection by removal of the clip
- Polished metal housing
- Rotatable electronic head for alignment of the 90° cable outlet
- LED for switching value display

Characteristics

The sensors work with a 16-bit processor, a 12-bit A/D and a 12-bit D/A converter. Linearisations and calibrations are carried out automatically. The Flash memory guarantees the exchangeability of all programs.

There is a choice between a switch with transistor output (push-pull) or a frequency output. The analog output 4..20 mA or 0..10 V can be used at the same time. Many options are available for the switching outputs.

- variable ranges for the analog outputs
- variable hystereses
- Minimum or maximum switch
- Inversion of the outputs
- Window function
- Delay after switching voltage on
- Switching delays (On, Off)

Technical data

Sensor	analog hall sensor	
Nominal width	DN 8..25	
Process connection	female thread G 1/4..G 1 (further process connections available on request)	
Metering range	0,5..60 l/min	for details see table "Ranges"
Pressure loss	1,1..3,5 bar bei Q _{max.}	
Q_{max.}	to 80 l/min	
Tolerance	±3 % of full scale value	
Media temperature	PN 200 bar optionally PN 500 bar	
Media temperature	-20..+85 °C optionally -20..+150 °C	

Ambient temperature	-20..+70 °C	
Media	oils	
Wiring	see section "Wiring"	
Supply voltage	18..30 V DC	
Power consumption	<1 W	
Analog output	4..20 mA / load 500 W max. or 0..10 V / load min. 1 kW	
Switching output	transistor output "push-pull", (resistant to short circuits, and reversal polarity protected) I _{out} = 100 mA max.	
Display (only with switching output)	yellow LED (On = OK / Off = Alarm)	
Ingress protection	IP 67	
Electrical connection	for round plug connector M12x1, 4-pole	
Materials medium-contact	<i>Brass construction:</i> CW614N nickelled, CW614N, 1.4310, hard ferrite, NBR	<i>Stainless steel construction:</i> 1.4571, 1.4404, 1.4310, hard ferrite PTFE-coated, FKM
Non-medium-contact materials	CW614N, PPS	
Weight	see table "Dimensions and weights"	
Installation location	Standard: horizontal inwards flow; other installation positions are possible; the installation position affects the metering and switching range.	

Signal output curves

Value x = Begin of the specified range

= not specified range

Current output

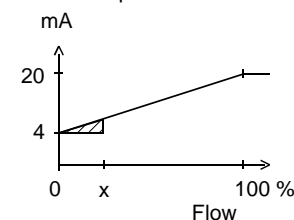

Voltage output

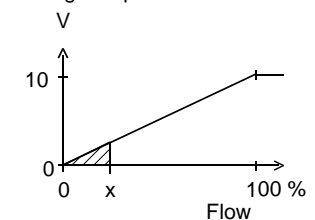

Frequency output

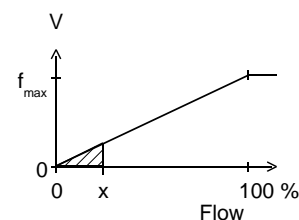

f_{max} selectable in the range of up to 2000 Hz

Other characters on request.

Ranges

Details in the table correspond to horizontal inwards flow with increasing flow rate.

Viscosity compensated type FLEX-HD2K

Metering range l/min oil 30..330 mm ² /s	Q _{max.} recommended	Pressure loss bar at Q _{max.} Oil mm ² /s				Viscosity stability ±8 %, min.
		60	100	205	330	
0.5 - 8	12	1.4	1.6	2.8	3.5	±0.3 l/min
1.5 - 15	22	2.3	2.4			±0.5 l/min
2.5 - 25	35	2.0	2.1	2.3	2.9	±0.8 l/min
6.0 - 40	60				2.6	±2.7 l/min
12.0 - 60	80	2.3	2.4	2.6	2.8	±3.0 l/min

Special ranges are available.

Wiring

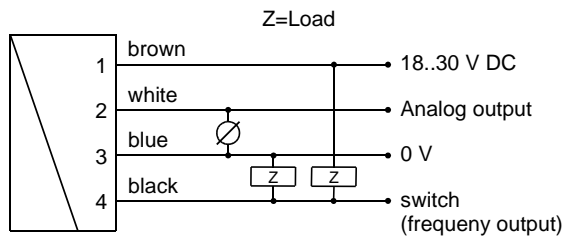

Connection example: PNP NPN

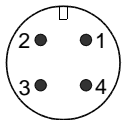

Dimensions and weights

	G	Types	SW	X	Weight kg
Brass	G 1/4	...-008GM	40	15	1.5
	G 3/8	...-010GM			
	G 1/2	...-015GM			
	G 3/4	...-020GM		18	1.4
	G 1	...-025GM			
Stainless steel	G 1/4	...-008GK	41	15	1.5
	G 3/8	...-010GK			
	G 1/2	...-015GK			
	G 3/4	...-020GK		18	1.4
	G 1	...-025GK			

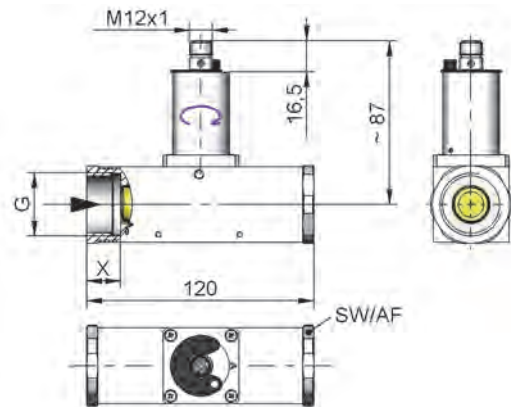

Handling and operation

Note

- Include straight calming section of 5 x DN in inlet and outlet
- Include a filter if the media are dirty (use magnetic filter for ferritic components)

The electronics housing is permanently connected to the primary sensor. There is no electrical connection between the electronics and the piston device. After installation, the electronic head can be turned to align the cable outlet.

It should be noted that the piston device and the FLEX electronics are appropriately matched to each other.

Programming

The electronics contain a magnetic contact, with the aid of which different parameters can be programmed. Programming takes place when a magnet clip is applied for a period between 0.5 and 2 seconds to the marking located on the label. If the contact time is longer or shorter than this, no programming takes place (protection against external magnetic fields).



After the programming ("teaching"), the clip can either be left on the device, or removed to protect data.

The device has a yellow LED which flashes during the programming pulse. During operation, the LED serves as a status display for the switching output.

In order to avoid the need to transit to an undesired operating status during "teaching", the device can be provided ex-works with a "teach-offset". The "teach-offset" value is added to the currently measured value before saving (or is subtracted if a negative value is entered).

Example: The switching value is to be set to 70 % of the metering range, because at this flow rate a critical process status is to be notified. However, only 50% can be achieved without danger. In this case, the device would be ordered with a "teach-offset" of +20 %. At 50 % in the process, a switching value of 70 % would then be stored during "teaching".

Normally, programming is used to set the limit switch. However, if desired, other parameters such as the end value of the analog or frequency output may also be set.

The limit switch can be used to monitor minimal or maximal.

With a minimum-switch, falling below the limit value causes a switchover to the alarm state. Return to the normal state occurs when the limit value plus the set hysteresis is again exceeded.

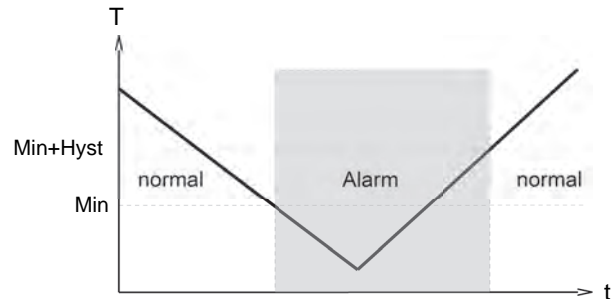

With a maximum-switch, exceeding the limit value causes a switchover to the alarm state. Return to the normal state occurs when the measured value once more falls below the limit value minus the set hysteresis.

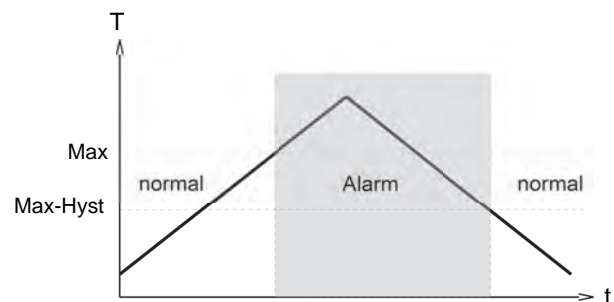

A switchover delay time (t_{DS}) can be applied to the switchover to the alarm state. Equally, one switch-back delay time (t_{DR}) of several can be applied to switching back to the normal state.

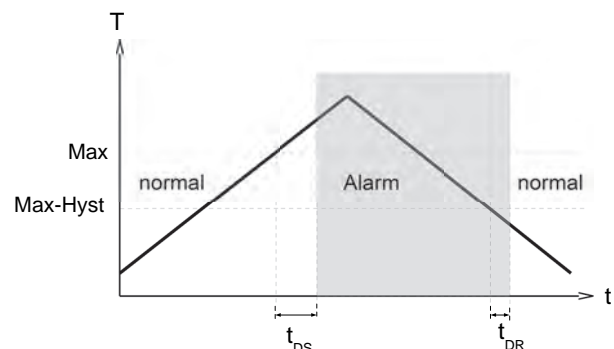

In the normal state the integrated LED is on, in the alarm state it is off, and this corresponds to its status when there is no supply voltage.

In the non-inverted (standard) model, while in the normal state the switching output is at the level of the supply voltage; in the alarm state it is at 0 V, so that a wire break would also display as an alarm state at the signal receiver. Optionally, an inverted switching output can also be provided, i.e. in the normal state the output is at 0 V, and in the alarm state it is at the level of the supply voltage.

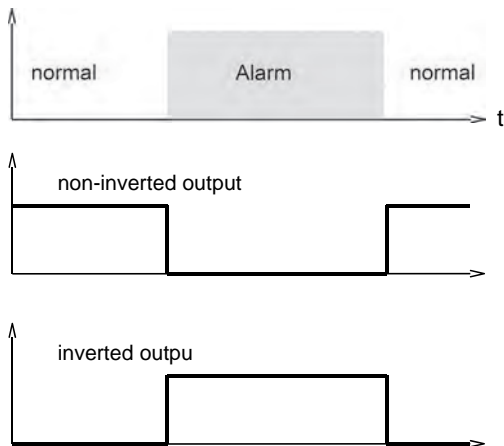

A Power-On delay function (ordered as a separate option) makes it possible to maintain the switching output in the normal state for a defined period after application of the supply voltage.

Combinations with FLEX

FLEX-converter / counter can be combined with very different types of pickup systems for flow rate, level, temperature, and pressure. This has created a family of sensors with which different types of applications can be supported.



Ordering code

The base device e.g. HD2K-015GM005E is ordered with electronics e.g. FLEX-HD2KIULO

HD2K - 1. 2. **G** 3. 4. 5. **E**

FLEX-HD2K 6. 7. 8. 9.

1. Nominal width	
008	DN 8 - G 1/4
010	DN 10 - G 3/8
015	DN 15 - G 1/2
020	DN 20 - G 3/4
025	DN 25 - G 1
2. Process connection	
G	female thread
3. Connection material	
M	brass
K	stainless steel
4. metering range oil 30..330 mm²/s for horizontal inwards flow	
008	0,5 - 8 l/min
015	1,5 - 15 l/min
025	2,5 - 25 l/min
040	6,0 - 40 l/min
060	12,0 - 60 l/min
5. Connection for	
E	electronics
6. Analog output	
I	current output 4..20 mA
U	voltage output 0..10 V
K	no analog output
7. Switching output	
T	push-pull (compatible with PNP and NPN)
K	no switching output
8. Function set to switching output	
L	minimum-switch
H	maximum-switch
R	frequency output
K	no switching output
9. Switching output level	
O	standard
I	inverted

Options for FLEX

Special range for analog output: <= Metering range (standard=metering range)	<input type="text"/> <input type="text"/> <input type="text"/> l/min
Special range for frequency output: <= Metering range (Standard=Metering range)	<input type="text"/> <input type="text"/> <input type="text"/> l/min
End frequency (max. 2000 Hz)	<input type="text"/> <input type="text"/> <input type="text"/> <input type="text"/> Hz
Power-on delay (from Alarm to OK)	<input type="text"/> <input type="text"/> s
Power-off delay (from OK to Alarm)	<input type="text"/> <input type="text"/> s
Power-On delay (0..99 s) (time after power on, during which the outputs are not actuated)	<input type="text"/> <input type="text"/> s
Switching output fixed	<input type="text"/> <input type="text"/> <input type="text"/> l/min
Special hysteresis (standard = 2 % EW)	<input type="text"/> <input type="text"/> %
Gooseneck (recommended at operating temperatures above 70 °C)	<input type="text"/> <input type="text"/> <input type="text"/> <input type="text"/>

If the field is not completed, the standard setting is selected automatically.

Options

- Special quantities
- Temperature display 0..120 °C

Accessories

- Cable/round plug connector (KB...) see additional information "Accessories"

Ordering information

- Specify direction of flow, medium, and metering range.
- For viscous media specify viscosity, temperature, and medium (e.g. ISO VG 68) (enquire about metering range).
- For gases, state pressure (relative or absolute), temperature and medium (e.g. air) (request metering range)