

Flow Transmitter VHZ

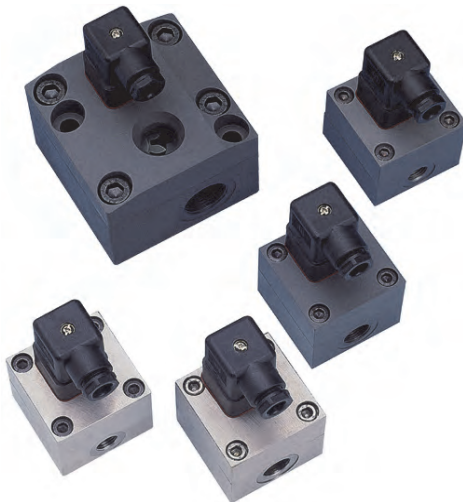

- Ideally suited for viscous media (oils)
- Light and compact construction in an aluminium housing
- For cost-sensitive applications

Characteristics

The VHZ gearwheel flow meter measures the flow by a volumetric principle, in which a pair of gearwheels is moved proportional to the flow rate. The movement of the gearwheels is measured through the enclosing housing wall by a sensor. The devices are suitable for viscous, fluid, self-lubricating media, as well as for aqueous fluids such as soaps, pasts, emulsions etc. which have a non-abrasive character. Because of the volumetric functioning principle, the devices are almost completely independent of viscosity.

A push-pull transistor output, an A / B output or a two wire output are available as signal output.

The push-pull output can as desired be connected as a PNP or an NPN output, and emits a frequency proportional to the flow rate.

The A / B output consists of two push-pull outputs, whose signals are phase-shifted by 90°. This makes it possible to determine the direction of flow using the bidirectionally driven sensor. The 2 wire model represents the pulse as two different currents, and has the advantage of reduced wiring effort.

Alternatively, it is possible to use add-on electronics with signal processing, in the series OMNI, FLEX and LABO.

Technical data

Sensor	gearwheel volumeter	
Nominal width	DN 8..25	
Process connection	female thread G 1/4..G 1	
Metering ranges	0.02..150 l/min for details, see table "Ranges"	
Measurement accuracy	±3 % of the measured value in the specified metering range (measured at 20 mm ² /s)	
Repeatability	±0,3 %	
Medium temperature	-25..+80 °C	
Ambient temperature	-20..+70 °C	
Pressure resistance	see table "Pressure resistance and Weight"	
Pressure loss	see upstream page "Function and benefits - volumetric, gearwheel"	
Materials medium-contact	see table "Materials"	
3 wire or A / B-output	Supply voltage	10..30 V DC
	Current consumption	approx. 20 mA without load
	Signal output	transistor output "push-pull" (resistant to short circuits and polarity reversal) I _{out} = 100 mA max.
2 wire	Supply voltage	4.5..24 V DC
	Signal output	Low: 7 mA High: 14 mA
	Reversed polarity protected	yes
Electrical connection	optional plug DIN 43650-A / ISO 4400 or for round plug connector M12x1, 4-pole	
Ingress protection	IP 65	
Weight	see table "Pressure resistance and weight"	
Conformity	CE	

Pressure resistance and weight

G	Types	PN bar	Housing material	Weight kg
G 1/4	VHZ-008GA	200	Aluminium	0.5
G 1/4	VHZ-008GK	160	Stainless steel	1.5
G 3/8	VHZ-010GA	160	Aluminium	0.5
G 3/8	VHZ-010GK	160	Stainless steel	1.5
G 3/4	VHZ-020GA	160	Aluminium	1.6
G 3/4	VHZO-020GA	100	Aluminium / glass	1.6
G 1	VHZ-025GA	80	Aluminium	6.3

Ranges

Metering range l/min	Types	Pulse volume cm ³	Frequency Hz at Q _{max}
0.02.. 2	VHZ-008	0.04	833
0.10.. 6	VHZ-010	0.20	500
0.50.. 50	VHZ(O)-020	2.00	417
3.00.. 150	VHZ-025	5.22	479

Materials

	VHZ-008GA	VHZ-010..025GA	VHZ-008GK	VHZ-010..025GK
Housing	Aluminium	Al anodised	stainless steel 1.4404	stainless steel 1.4404
gear-wheel and Axis	stainless steel 1.4462	stainless steel 1.4462	stainless steel 1.4462	stainless steel 1.4462
Bea- ring	Stainless steel ball bearings 1.4037 / 1.4016 / PVD coated	Iglidur X	stainless steel 1.4037 / 1.4016 /PVD-coated	Iglidur X
Seal	FKM	FKM	FKM	FKM
Sight glass		Glass (only with VHZO)		

Wiring

Before the electrical installation, it must be ensured that the supply voltage complies with the data sheet. The use of shielded cabling is recommended.

Push-pull output

with round plug connector M12x1

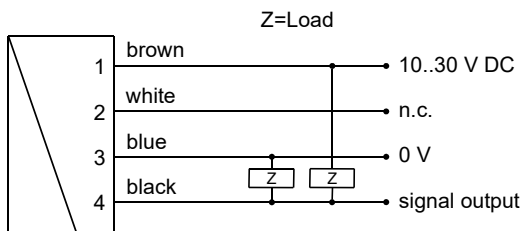

Connection example: PNP NPN

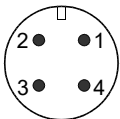

with plug as per DIN 43650-A / ISO 4400

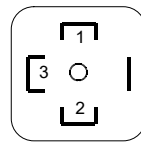
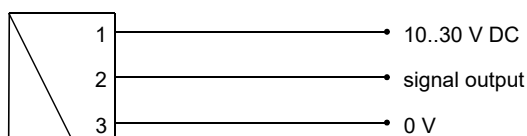

A / B output

only with 4-pole round plug connector

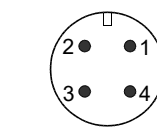
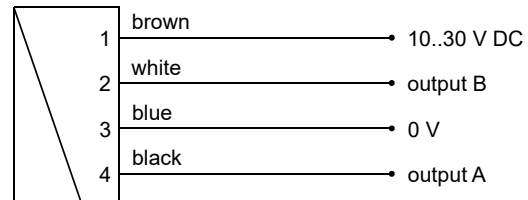

2 wire model

with plug as per DIN 43650-A / ISO 4400

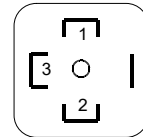
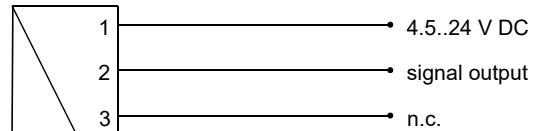

with round plug connector M12x1

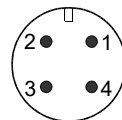
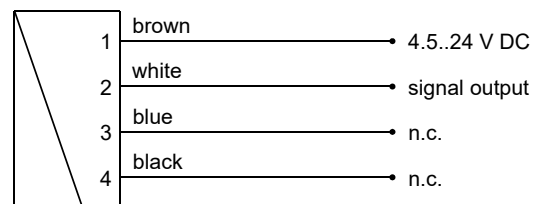

Dimensions

VHZ-008

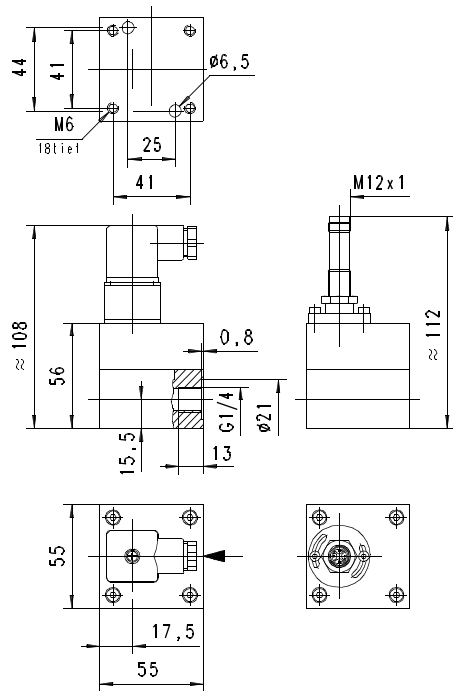

VHZ-020

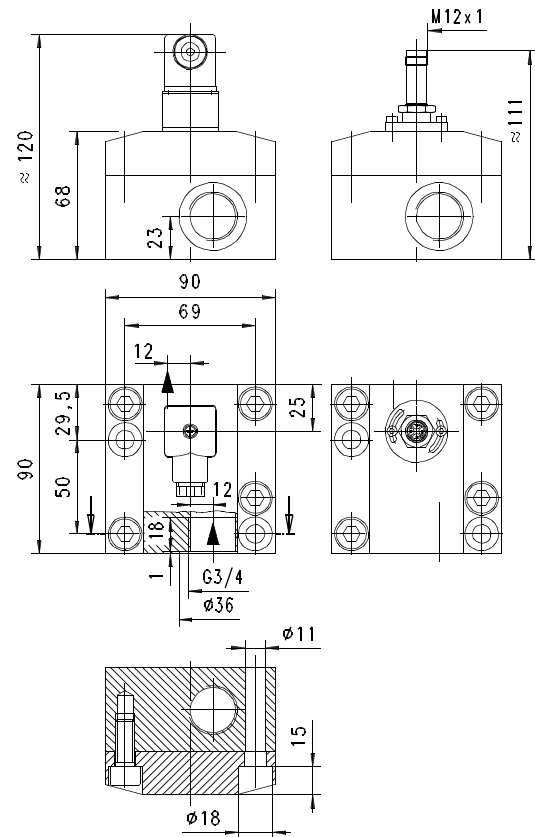

VHZ-010

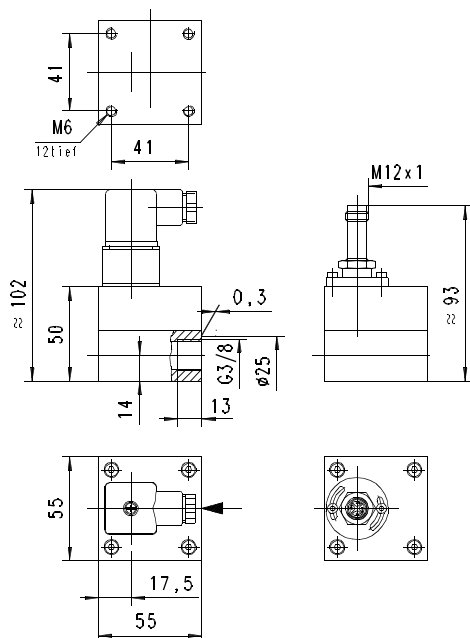

VHZ-025

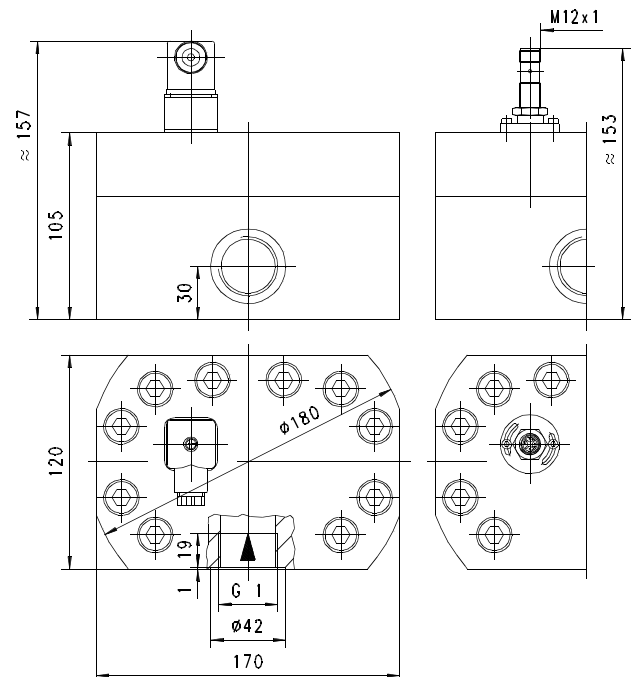

Handling and Operation

Installation

The VHZ flow measurement device can be installed anywhere in the pipework system. A run-in section is not required. The direction of flow may be freely chosen. It should be ensured that no dirt particles (thread cutting swarf!) can get into the flow space, as this could cause the blockage of the gearwheels. It may therefore be necessary to install filters upstream of the flow measurement device (mesh size 30 µm).

Ordering code

VHZ- 1. 2. 3. 4. 5. 6. 7.
 G

○=Option

1. Sight glass					
-	no sight glass				
O-	with sight glass				
2. Nominal width					
008	DN 8 - G 1/4				●
010	DN 10 - G 3/8				●
020	DN 20 - G 3/4				● ●
025	DN 25 - G 1				●
3. Process connection					
G	female thread				
4. Body material					
A	aluminium	●	●	●	●
K	○ stainless steel			●	●
5. Ranges					
002	0.02.. 2 l/min				●
006	0.10.. 6 l/min				●
050	0.50.. 50 l/min			●	
150	3.00..150 l/min	●			
6. Signal output					
M	push-pull transistor output	●	●	●	●
A	○ A / B output (2 x push-pull)	●	●	●	●
Z	○ 2 wire	●	●	●	●
7. Electrical connection					
B	plug DIN 43650A / ISO 4400				
S	○ for round plug connector M12x1, 4-pole				

Attention: The A / B output requires the use of a 4-pole round plug connector!

Options

- Highest temperature 120 °C

Accessories

- Cable/round plug connector (KB...) see additional information "Accessories"
- Remote flow display OMNI-TA