

Flow Transmitter / Screw Volumeter VHS



- Measures and monitors viscous media (oil) 1.4..2500 l/min
- Connection G 1..G 2 1/2
- Very low dependence on viscosity
- Can be used up to 40,000 mm²/s (cSt)
- Linear frequency output (push-pull)
- Light and compact device (aluminium housing)
- Operation and measurement possible with forwards and reverse flow
- For cost-sensitive applications

Characteristics

The VHS flow transmitter measures the flow using the volumetric principle, and is suitable for fluid, viscous, lubricant media (e.g. lubricating oil). If the material for the VHS is selected appropriately, aqueous fluids such as soaps, pastes, and emulsions with non-abrasive characteristics can also be measured, as long as they have sufficient lubricity. Because of the volumetric functioning principle, the device is almost completely independent of viscosity. The VHS system consists of two interlacing screws which run in opposite directions, driven by the flowing medium. A magnetically pre-tensioned Hall sensor positioned outside the flow space detects the screw flanks, and creates a frequency signal proportional to the flow. Here, two pulses correspond to one revolution of the screws, and therefore to a specific measured volume (see data table) There are no magnets in the flow space. A push-pull transistor output, an A / B output or a two wire output are available as signal output. The push-pull output can as desired be switched as a PNP or an NPN output, and emits a frequency proportional to the flow rate.

The A / B output consists of two push-pull outputs, whose signals are phase-shifted by 90 °. This makes it possible to determine the direction of flow using the bidirectionally driven sensor.

The 2 wire model represents the pulse as two different currents, and has the advantage of reduced wiring effort. Alternatively, it is possible to use add-on electronics with signal processing, in the series OMNI, FLEX and LABO.

The device bodies are made of aluminium, and the connections either of aluminium (achieves PN 160 bar) or steel (achieves PN 350 bar). Optionally, both process connections can be fitted with SAE flanges, which simplify the installation in the pipework, and in both cases achieve a pressure resistance of PN 350.

Technical data

Sensor	screw volumeter		
Nominal width	DN 25..65		
Process connection	female thread G 1..G 2 1/2		
Metering ranges	see table "Ranges"		
Measurement accuracy	±1 % of the measured value (at 20 mm ² /s, (cSt) of 1 %..100 % nominal working range (see also diagram in upstream pages)		
Repeatability	±0,25 %		
Pressure resistance	Connection material	SAE flange	PN bar
	aluminium	without	160
	aluminium	with	350
	steel	without	350
	steel	with	350
	others available on request		
Pressure loss	see diagrams in upstream pages		
Medium	oil or non-aggressive self-lubricating fluids		
Medium temperature	-25..+80 °C (150 °C available on request)		
Materials medium-contact	(special materials available on request):		
1. Body	Aluminium 6082 anodised		
2. Connections:	Aluminium 6082 anodised or steel		
3. Main screw	Steel 35SMnPb10 UNI 4838-80		
4. Subsidiary screw	GHISA GJL-250 EN1561		
5. Ball bearing	Steel		
6. Ball bearing	Steel		
7. Screws	Galvanised steel		
8. O-ring	NBR		
9. Seeger ring	Steel		
10. Seeger ring	Steel		
11. O-ring	NBR		
12. SAE connection	ASTM A216WCB		
13. SAE flange	ASTM A216WCB		
14. O-ring	NBR		
15. Screws	Galvanised steel		
16. Sensor spacer	Aluminium 6082 anodised		
3 wire or A / B-output	Supply voltage	10..30 V DC	
	Curr. consumpt.	approx. 20 mA without load	
	Signal output	Transistor output "push-pull" (resistant to short circuits and reversed polarity protected) I _{out} = 100 mA max.	

2 wire	Supply voltage	4.5..24 V DC
	Signal output	Low: 7 mA High: 14 mA

Reversed polarity protected	yes
------------------------------------	-----

Electrical connection	plug DIN 43650-A / ISO 4400 or for round plug connector M12x1, 4-pole
Ingress protection	IP 67

Weight	see table "Ranges and weights"
Conformity	CE

Ranges and weights

● = Standard ○ = Option

G	DN		Metering range	Volume / pulse	pulses / litre	Output frequency at Q_{nom}	Output frequency at Q_{max}	Types	Q_{max} recommended
			1..100 % Q_{nom}	cm ³	litre	Hz	Hz		l/min
G 1	DN 25	●	1.4.. 140	13.10	76.340	178.1	254.5	VHS-025...0140	200
G 1 ^{1/4}	DN 32	●	3.5.. 350	29.00	34.480	201.1	287.4	VHS-032...0350	500
G 1 ^{1/2}	DN 40	○	5.5.. 550	48.58	20.590	188.7	274.5	VHS-040...0550	800
		●	8.0.. 800	72.00	13.890	185.2	277.8	VHS-040...0800	1200
G 2	DN 50	○	10.0..1000	103.63	9.650	160.6	257.3	VHS-050...1000	1600
		●	15.0..1500	133.00	7.519	188.0	275.7	VHS-050...1500	2200
G 2 ^{1/2}	DN 65	●	25.0..2500	238.82	4.187	174.5	265.2	VHS-065...2500	3800

G	DN...range		Body with aluminium connections	Body with steel connections	SAE Flanges (Weight per pair)
			kg	kg	kg
G 1	025...0140	●	3.44	4.76	5.76
G 1 ^{1/4}	032...0350	●	6.35	8.50	9.55
G 1 ^{1/2}	040...0550	○	10.50	13.60	15.10
	040...0800	●	14.20	18.50	18.80
G 2	050...1000	○	20.70	27.70	30.30
	050...1500	●	25.00	33.20	34.60
G 2 ^{1/2}	065...2500	●	42.70	56.10	60.70

Wiring

Before the electrical installation, it must be ensured that the supply voltage corresponds with the data sheet. The use of shielded cabling is recommended.

with plug as per DIN 43650-A / ISO 4400

Push-pull output

with 4-pole round plug connector

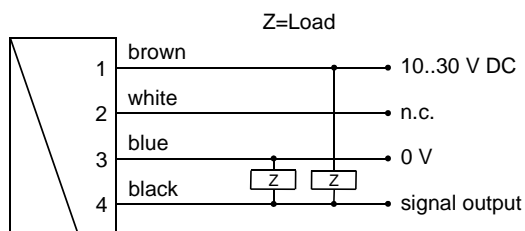

Connection example: PNP NPN

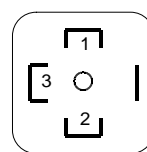
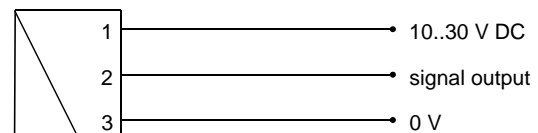
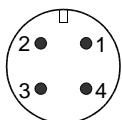

A / B output

only with 4-pole round plug connector

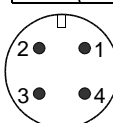
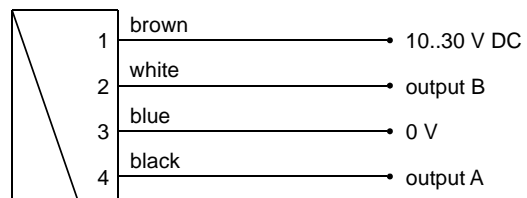

2 wire model

with 4-pole round plug connector

with plug as per DIN 43650-A / ISO 4400

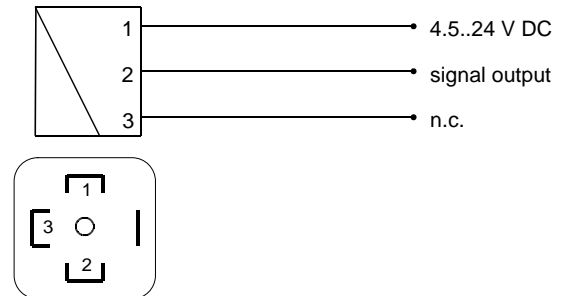
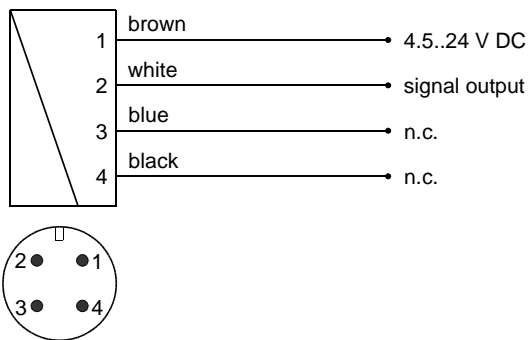

Dimensions

● = Standard ○ = Option

G	DN...range	x1	L1	ØD	SW	A	VHS...GAO...				VHS...GAX...			
							M	x2	B	C	L2	H	E	F
G 1	025...0140	● 20	220	88	78	49.0	12	20	57.1	27.8	324	52	80	69
G 1 ^{1/4}	032...0350	● 22	285	103	-	55.0	14	22	66.7	31.6	381	48	94	77
G 1 ^{1/2}	040...0550	○ 24	332	122	-	58.8	16	24	79.4	36.5	448	58	106	89
	040...0800	●	340	138	-	66.5					456			
G 2	050...1000	○ 33	396	155	-	71.0	20	35	96.8	44.4	544	74	135	116
	050...1500	●	405	168	-	77.3					553			
G 2 ^{1/2}	065...2500	● 35	475	203	-	86.0	24	42	123.8	58.7	633	79	166	150

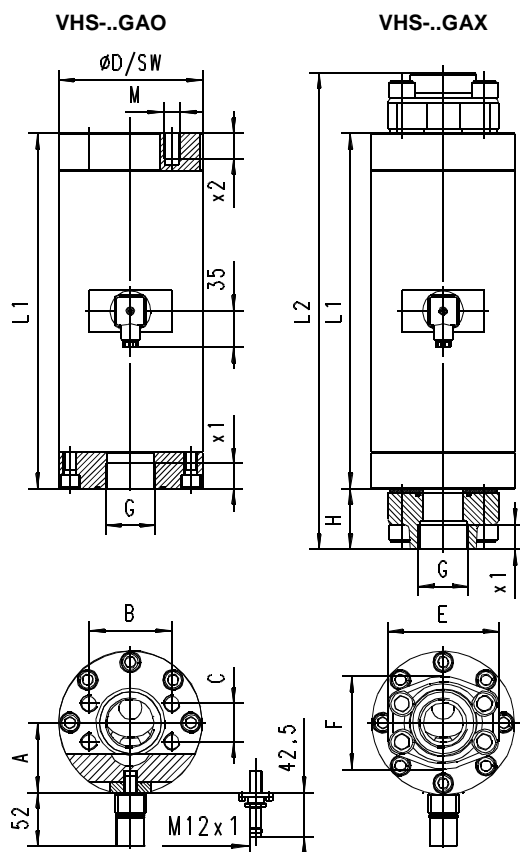

SAE adapter for convenient installation and for increased stability to pressure! (350 bar)

Handling and operation

Installation

Any flow direction is possible during installation. Ensure that pipework is clean. Flush before installation. A filter with 30 µm mesh filter should be used. The use of SAE flanges enables the sensor to be installed and removed more easily, and increases the stability to pressure to 350 bar for every connection material. It is possible to replace the electronics during operation, and this presents no danger to the fitter. The sensor does not go into the flow space.

Ordering code

VHS - 1. 2. 3. 4. 5. 6. 7. 8. 9. 10.
 G **A** **N**

○=Option

1. Nominal width						
025	DN 25 - G 1					
032	DN 32 - G 1¼					
040	DN 40 - G 1½					
050	DN 50 - G 2					
065	DN 65 - G 2½					
2. Process connection						
G	female thread					
3. Connection material						
A	AL connection, anodised (160 bar, in combination with SAE flange: 350 bar)					
S	<input type="radio"/> Connection, steel (350 bar)					
4. Additional flange						
X	SAE flange, steel (350 bar)					
O	no SAE flange (pressure resistance depends on the connection material)					
5. Body material						
A	anodised aluminium					
6. Metering range						
0140	1.4.. 140 l/min	<input type="checkbox"/>	<input type="checkbox"/>	<input type="checkbox"/>	<input type="checkbox"/>	<input checked="" type="checkbox"/>
0350	3.5.. 350 l/min	<input type="checkbox"/>	<input type="checkbox"/>	<input type="checkbox"/>	<input type="checkbox"/>	<input checked="" type="checkbox"/>
0550	<input type="radio"/> 5.5.. 550 l/min	<input type="checkbox"/>	<input type="checkbox"/>	<input type="checkbox"/>	<input type="checkbox"/>	<input checked="" type="checkbox"/>
0800	8.0.. 800 l/min	<input type="checkbox"/>	<input type="checkbox"/>	<input type="checkbox"/>	<input type="checkbox"/>	<input checked="" type="checkbox"/>
1000	<input type="radio"/> 10.0..1000 l/min	<input type="checkbox"/>	<input type="checkbox"/>	<input type="checkbox"/>	<input type="checkbox"/>	<input checked="" type="checkbox"/>
1500	15.0..1500 l/min	<input type="checkbox"/>	<input type="checkbox"/>	<input type="checkbox"/>	<input type="checkbox"/>	<input checked="" type="checkbox"/>
2500	25.0..2500 l/min	<input type="checkbox"/>	<input type="checkbox"/>	<input type="checkbox"/>	<input type="checkbox"/>	<input checked="" type="checkbox"/>
7. Seal material						
N	NBR					
V	<input type="radio"/> FKM					
8. Signal output						
M	push-pull transistor output					
A	<input type="radio"/> A / B output (2 x push-pull)					
Z	<input type="radio"/> 2 wire					
9. Electrical connection						
B	plug DIN 43650-A / ISO 4400					
S	<input type="radio"/> for round plug connector M12x1, 4-pole					
10. Option						
H	<input type="radio"/> high temperature model only for M12x1 Plug, electronics recessed by 30 cm					

Accessories

- Cable/round plug connector (KB...) see additional information "Accessories"

Accessories

- External counter EEZ-904
- External counter OMNI-C (panel-mounting IP 67)
- External display / converter OMNI-TA (panel-mounting IP 67)
- External display / converter OMNI-REMOTE (panel-mounting IP 67)