

Flow Switch LABO-VHZ-S



- Volumetric flow switching
- Almost no effect from differing viscosities
- Versatile, configurable switching output in push-pull design
- Robust construction
- Compact design

Characteristics

The VHZ gearwheel flow meter measures the flow by a volumetric principle, in which a pair of gearwheels is moved proportional to the flow rate. The movement of the gearwheels is measured through the enclosing housing wall by a sensor. The devices are suitable for viscous, fluid, self-lubricating media, as well as for aqueous fluids such as soaps, pasts, emulsions etc. which have a non-abrasive character. Because of the volumetric functioning principle, the devices are almost completely independent of viscosity.

The LABO electronics fitted to the device make available an electronic switching output (push-pull) with adjustable characteristics (minimum/maximum) and hysteresis, which responds when an adjustable limit is fallen short of or exceeded.

If desired, the switching value can be set to the currently existing flow using "teaching". Models with analog or pulse output are also available (see separate data sheets).

Technical data

Sensor	gearwheel volumeter	
Nominal width	DN 8..25	
Process connection	female thread G 1/4..G 1	
Switching ranges	0.02..150 l/min for details, see table "Ranges"	
Measurement accuracy	±3 % of the measured value in the specified metering range (measured at 20 mm ² /s)	
Repeatability	±0,3 %	
Medium temperature	-25..+80 °C optionally -25..+120 °C	
Ambient temperature	-20..+70 °C	
Pressure resistance	see table "Pressure resistance and weight"	
Pressure loss	see upstream page "Function and benefits - volumetric, gearwheel"	
Materials medium-contact	see table "Materials"	
Materials, non-medium-contact	Sensor tube	CW614N nickelled
	Adhesive	Epoxy resin
	Flange bolts	stainless steel
Supply voltage	10..30 V DC	
Power consumption	< 1 W (for no-load output)	
Switching output	transistor output "push-pull" (resistant to short circuits and polarity reversal) I _{out} = 100 mA max.	
Display	yellow LED (On = Normal / Off = Alarm / rapid flashing = Programming)	
Electrical connection	for round plug connector M12x1, 4-pole	
Ingress protection	IP 67	
Weight	see table "Pressure resistance and weight"	
Conformity	CE	

Pressure resistance and weight

G	Types	PN bar	Housing material	Weight kg
G 1/4	LABO-VHZ-008GA	200	Aluminium	0.5
G 1/4	LABO-VHZ-008GK	160	stainless steel	1.5
G 3/8	LABO-VHZ-010GA	160	Aluminium	0.5
G 3/8	LABO-VHZ-010GK	160	stainless steel	1.5
G 3/4	LABO-VHZ-020GA	160	Aluminium	1.6
G 3/4	LABO-VHZO-020GA	100	Aluminium / glass	1.6
G 1	LABO-VHZ-025GA	80	Aluminium	6.3

Ranges

Metering range	Types	Pulse volume (= resolution) cm ³
l/min		
0.02.. 2	LABO-VHZ-008	0.04
0.10.. 6	LABO-VHZ-010	0.20
0.50.. 50	LABO-VHZ(O)-020	2.00
3.00.. 50	LABO-VHZ-025	5.22

Materials

	LABO-VHZ-008..025GA	LABO-VHZ-008GK	LABO-VHZ-010..025GK
Housing	Al anodised	stainless steel 1.4404	stainless steel 1.4404
gearwheel and Axis	stainless steel 1.4462	stainless steel 1.4462	stainless steel 1.4462
Bearing	Iglidur X	stainless steel 1.4037 / 1.4016 /PVD-coated	Iglidur X
Seal	FKM	FKM	FKM
Sight glass	glass (only with VHZO)		

Dimensions

LABO-VHZ-008

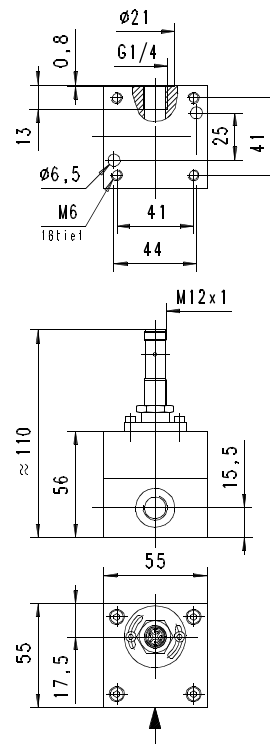

Wiring

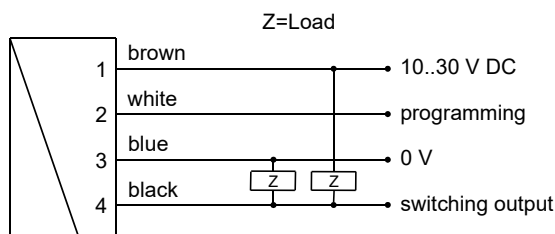

Connection example: PNP NPN

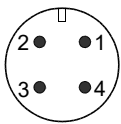

Before the electrical installation, it must be ensured that the supply voltage corresponds to the data sheet. It is recommended to use shielded wiring.

LABO-VHZ-010

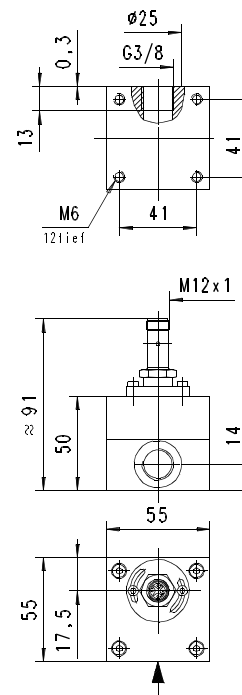

LABO-VHZ-020

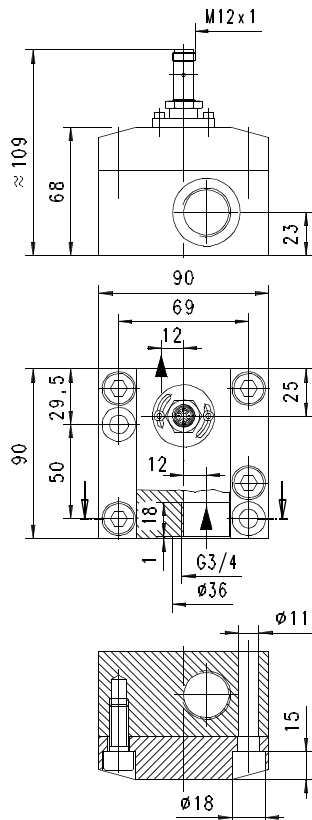

LABO-VHZ-025

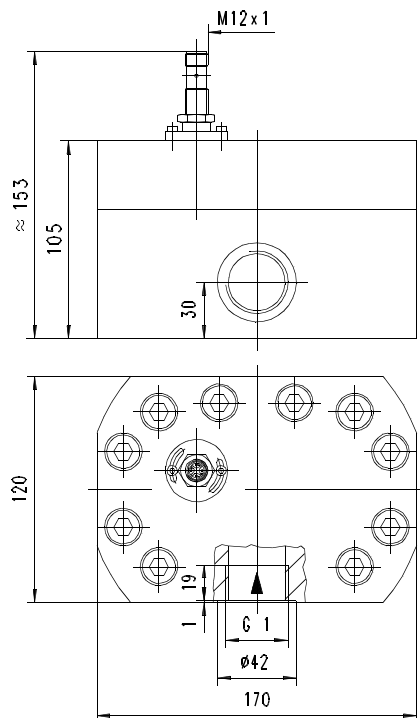

Handling and operation

Installation

The VHZ flow measurement device can be installed anywhere in the pipework system. A run-in section is not required. The direction of flow may be freely chosen.

It should be ensured that no dirt particles (thread cutting swarf) can get into the flow space, as this could cause the blockage of the gearwheels. It may therefore be necessary to install filters upstream of the flow measurement device (mesh size 30 µm).

Note

The switching value can be programmed by the user via "teaching". If desired, programmability can be blocked by the manufacturer.

The ECI-1 device configurator with associated software is available as a convenient option for programming all parameters by PC, and for adjustment.

Operation and programming

The switching value is set as follows:

- Apply the flow rate to be set to the device.
- Apply an impulse of at least 0.5 seconds and max. 2 seconds duration to pin 2 (e.g. via a bridge to the supply voltage or a pulse from the PLC), in order to accept the measured value.
- When the teaching is complete, pin 2 should be connected to 0 V, so as to prevent unintended programming.

The device has a yellow LED which flashes during the programming pulse. During operation, the LED serves as a status display for the switching output.

In order to avoid the need to transit to an undesired operating status during the teach-in, the device can be provided ex-works with a teach-offset. The teach-offset point is added to the currently measured value before saving. The offset point can be positive or negative.

Example: The switching value should be set to 80 l/min. However, it is possible only to reach 60 l/min without problems. In this case, the device would be set using a teach-offset of +20 l/min. At a flow rate of 60 l/min in the process, teaching would then store a value of 80 l/min.

The limit switch can be used to monitor minimal or maximal.

With a minimum-switch, falling below the limit value causes a switchover to the alarm state. Return to the normal state occurs when the limit value plus the set hysteresis is once more exceeded.

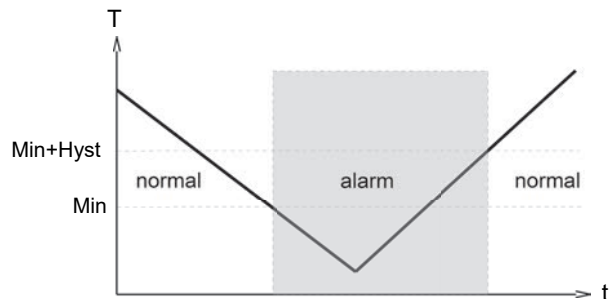

With a maximum-switch, exceeding the limit value causes a switch-over to the alarm state. Return to the normal state occurs when the measured value once more falls below the limit value minus the set hysteresis.

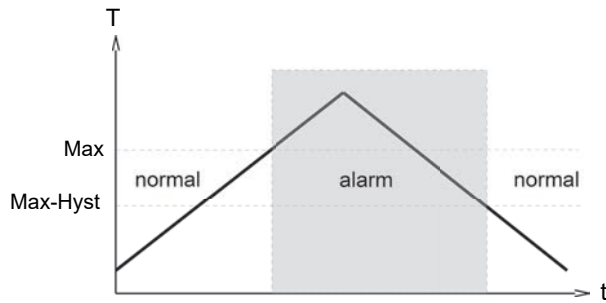

A switchover delay time (t_{DS}) can be applied to the switchover to the alarm state. Equally, one switch-back delay time (t_{DR}) of several can

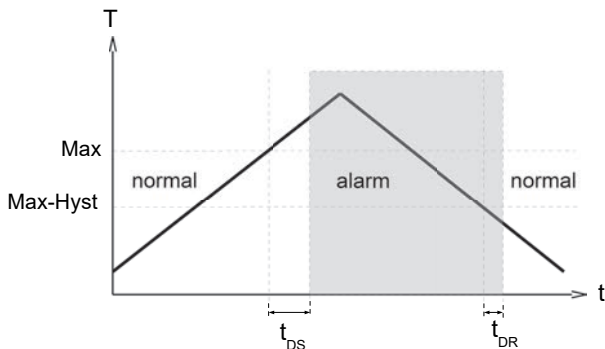

be applied to switching back to the normal state. In the normal state the integrated LED is on, in the alarm state it is off, and this corresponds to its status when there is no supply voltage.

In the non-inverted (standard) model, while in the normal state the switching output is at the level of the supply voltage; in the alarm state it is at 0 V, so that a wire break would also display as an alarm state at the signal receiver. Optionally, an inverted switching output can also be provided, i.e. in the normal state the output is at 0 V, and in the alarm state it is at the level of the supply voltage.

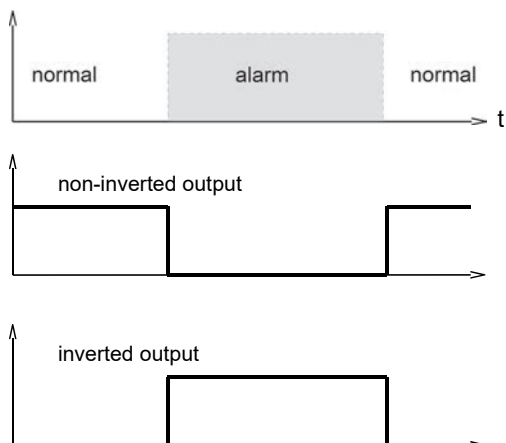

A Power-On-Delay function (ordered as a separate option) makes it possible to maintain the switching output in the normal state for a defined period after application of the supply voltage.

Ordering code

The base device is ordered, e.g. VHZ-008GA002E with electronics, e.g. OMNI-VHZ-008IPLO

VHZ-

LABO-VHZ-

○=Option

1. Sight glass					
-	no sight glass				
O	with sight glass				
2. Nominal width					
008	DN 8 - G 1/4				•
010	DN 10 - G 3/8				•
020	DN 20 - G 3/4				•
025	DN 25 - G 1				•
3. Process connection					
G	female thread				
4. Body material					
A	aluminium		•	•	•
K	○ stainless steel			•	•
5. Ranges					
002	0.02.. 2 l/min				•
006	0.10.. 6 l/min				•
050	0.50.. 50 l/min			•	
150	3.00.. 150 l/min		•		
6. Connection for					
E	electronics		•	•	•
7. For base device					
008	VHZ-008G....E				•
010	VHZ-010G....E				•
020	VHZ(O)-020G....E			•	
025	VHZ-025G....E		•		
8. Switching output (Limit switch)					
S	push-pull (compatible with PNP and NPN)				
9. Programming					
N	cannot be programmed (no teaching)				
P	○ programmable (teaching possible)				
10. Switching function					
L	minimum-switch				
H	maximum-switch				
11. Switching signal					
O	standard				
I	○ inverted				
12. Electrical connection					
S	for round plug connector M12x1, 4-pole				
13. Option					
H	○ medium temperature max. 120 °C (with 300 mm cable)				

Options

Switching delay period (0.0..99.9 s)
(from Normal to Alarm) . s

Switch-back delay period (0.0..99.9 s)
(from Alarm to Normal) . s

Power-On delay period (0..99 s)
(after connecting the supply, time during
which the outputs are not actuated) s

Switching output fixed at l/min

Switching hysteresis %
standard = 2 % of the metering range

Teach-offset %
(in percent of the metering range)
standard = 0 %

Further options available on request.

Accessories

- Cable/round plug connector (KB...)
see additional information "Accessories"
- Device configurator ECI-1