

Multifunction controller GHM-ONE MSR9696H



- Visualisation system with 3.5" TFT display
- Control unit with 4 function keys and touch display
- Modular I/O concept
- PID control function
- Multi-Loop system
- Profiler function
- Process control with more than 100 functions
- Process calculation with mathematical library
- Screen recorder function
- Data logger function
- Communications card with various field buses

Features

The GHM ONE is a multifunction unit that can be specifically adapted to process and control requirements with the GHM CAT configuration software. Therefore, the system becomes an ideal control, regulating, and operating unit.

The GHM ONE gives the user the possibility of effectively implementing their ideas in the areas of automation and visualisation without the need for programming skills. The platform is an ideal basis for a wide range of applications, including:

- Industrial furnaces
- Laboratory ovens
- Heat treatment systems
- Microbreweries
- Dryers
- Test stands
- Building automation
- Climate control
- Pasteurisation systems

The MSR9696H is based on a powerful processor which, in combination with a relay card and mains adapter card, serves as the base unit. The base unit can be adapted to applications with a communications card and up to 2 I/O cards. The number of physical inputs and outputs can be expanded with external I/O's. This modular layout enables specific adaptation of the hardware to the automation task. The creation of the application itself takes place in the MSR 9696H with the 'Configuration and Application Tool' CAT. The software assists the user with more than 100 complete function blocks and intuitive operation for the implementation of their ideas.

This saves time when creating applications with high operational reliability.

Quick and easy to put ideas into practice

The creation of applications is child's play with the MSR 9696H. Based on the concept of connecting of existing function blocks, the user creates applications comprising process controls, mathematical calculations and process regulation in the shortest possible time. For this purpose the CAT configuration software provides a function library with more than 100 tested functions from the following areas:

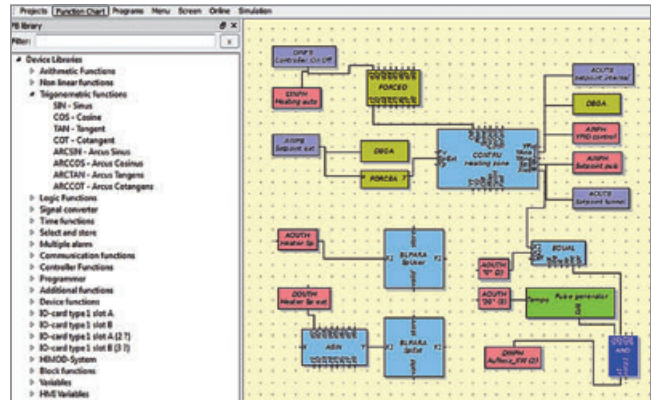

- Input and output signals
- Computing functions
- Logic functions
- Signal conversion
- Time functions
- Memory functions
- Communications functions
- Profiler functions
- Regulating functions

The user only has to combine and connect these functions in the editor and thereby implement their idea without the need for any programming skills. Testing of the individual functions is omitted, because they are provided ready-to-use, and were not created by the user. Therefore, the user can concentrate entirely on implementing their idea. In addition to the support provided to the user by the function library, the CAT configuration tool offers additional functions in the editor. For instance, the user can structure their application in order to maintain an overview, create their own function blocks for recurring functions in order to save time, and test sub-areas of their application independently of other project areas with simulation functions.

With consistent use of the latest software architectures and functions, it is possible for the user to realise their application with CAT without an extensive familiarisation period.

Product information Multifunction controller

Multifunctional control

Individual operating and monitoring concepts

The work does not end with the creation of pure process control and regulation for modern machine and system parts. The process technician must provide the operator on site with the possibility of effectively monitoring and operating the system. The user must also remain well-informed in the event of a fault in order to keep the system downtime to an absolute minimum. Standard operating concepts are of little help in this connection. Therefore, the MSR 9696H is based on a concept that enables individual design of the operation and visualisation.

For this purpose, the CAT software provides an image editor that makes it possible to realise the widest range of operating and monitoring concepts with a few simple standard functions. In addition to the individual operating screens, there are standards screens such as:

Regulator operation	Program controller operation
Trend visualisation	Parameter dialogue

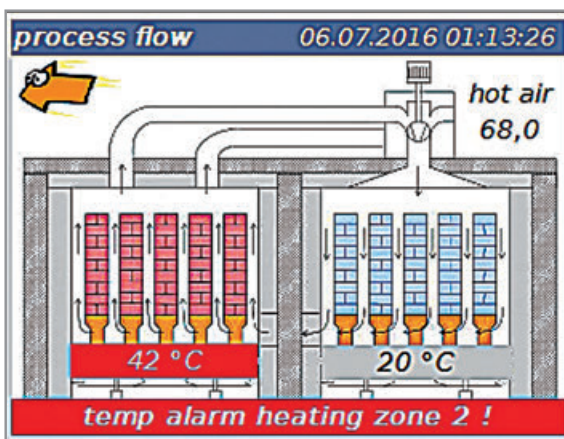
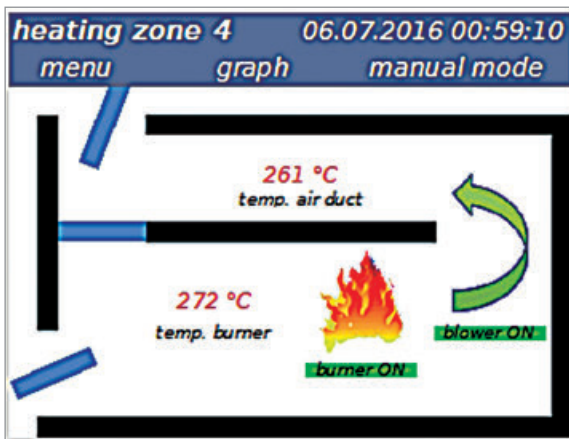

available in the screen editor. With the combination of standard operating screens and individually designed screen, an efficient interface between the operator and the process is created in the shortest time.

Thanks to the efficient software structure, even complex operating structures are easy to realise with the image editor.

Commissioning and testing quickly and easily

Of course, the process technician's work is not finished with the creation of an application and its operation. The application still has to be tested and commissioned afterwards. For this important and in some cases lengthy phase, the new GHM platform provides various functions to streamline this phase.

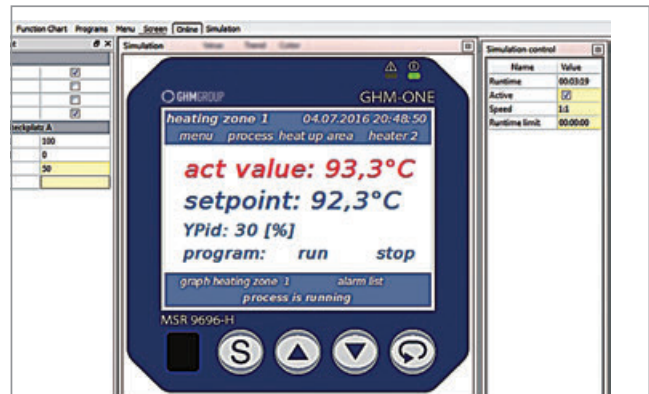

An essential point is the PC simulation of the complete application. The entire application can be tested on a PC independently of the actual process. For this purpose, the CAT software has a simulation environment for the MSR 9696H and for connected I/O assemblies. With this environment, the user is capable of testing the entire application, including operation on the PC, without endangering the real process. Simply test the application at a desk without risk.

There are additional testing functions available to the user for the on-site system commissioning phase. An essential component is an integrated online trend function that allows the user to view all analogue and digital signals online in a trend and thereby quickly and easily monitor the desired functions. Of course, there are also debugging and various forcing functions available for the testing.

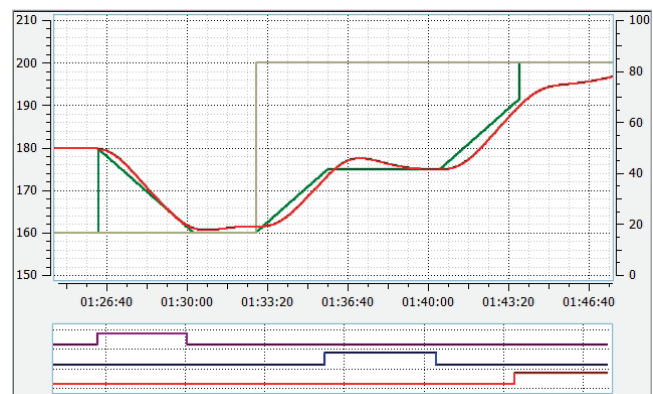

Simulation on a PC significantly shortens testing and commissioning times and increases system safety.

Product information Multifunction controller

Application designer in CAT

CAT software configuration tool

The CAT (Configuration and Application Tool) tool enables the user to completely configure the GHM ONE. It essentially comprises the function plan editor, the HMI editor, the menu editor, the simulation, and commissioning assistance with debugging function and online diagrams.

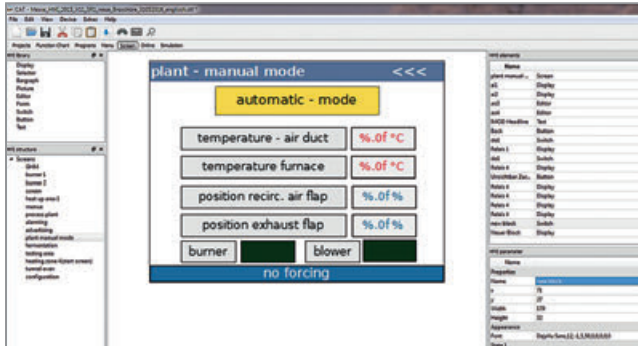

The major functions are:

- Creation of the application from finished functions found in various libraries
- Graphic linking of functions in the function plan editor
- Automatic alignment of connections
- Parameterisation of functions
- Creation of operating structure and visualisation (HMI)
- Creation of test menus for parameterisation on the GHM ONE
- Creation of programs for the program controller
- Simulation of the overall application on the PC, including simulation of control paths
- Online device function with debugging functions for application testing
- Transfer of applications to the GHM ONE.
- Firmware update function
- Online help for all functions

The core of the application creation is the function plan editor with the function module library. With the help of the function modules, the user assembles their application without the need for any programming skills. There are more than 100 tested functions in the library which can be easily placed on the desktop and connected using the mouse. Declaring of variables and complex assignment of functions are omitted. In this manner, the user can effectively create their system or process from finished modules. The application operating and monitoring screens are then created based on the function block application. Therefore, specific information can be displayed for the person on site and detailed screens can be created for service technicians. These screens are freely configurable. It is even possible to integrate process screens or other graphics. The user can also create text-based operating screens in order to enable efficient input of several types of process data.

After the application has been created, it can also be tested in the CAT tool. With the simulation, the software offers an exact representation of the device in all its functions. Even the hardware inputs and outputs can be simulated. Therefore, the user can test the application in an initial step without any risk for the system. Support of the user by the CAT software continues in the scope of the commissioning with various forcing and debugging functions and a refined online visualisation of analogue and digital values. With this wide variety of information and intervention possibilities, efficient commissioning is practically assured.

All configurations for the GHM One takes place in a single tool. The elaborate orientation in various software packages for controllers, data monitors, data loggers, mini-SCADA and mini-PLC can be dispensed with.

Application commissioning and testing times are minimised with a complete device simulation.

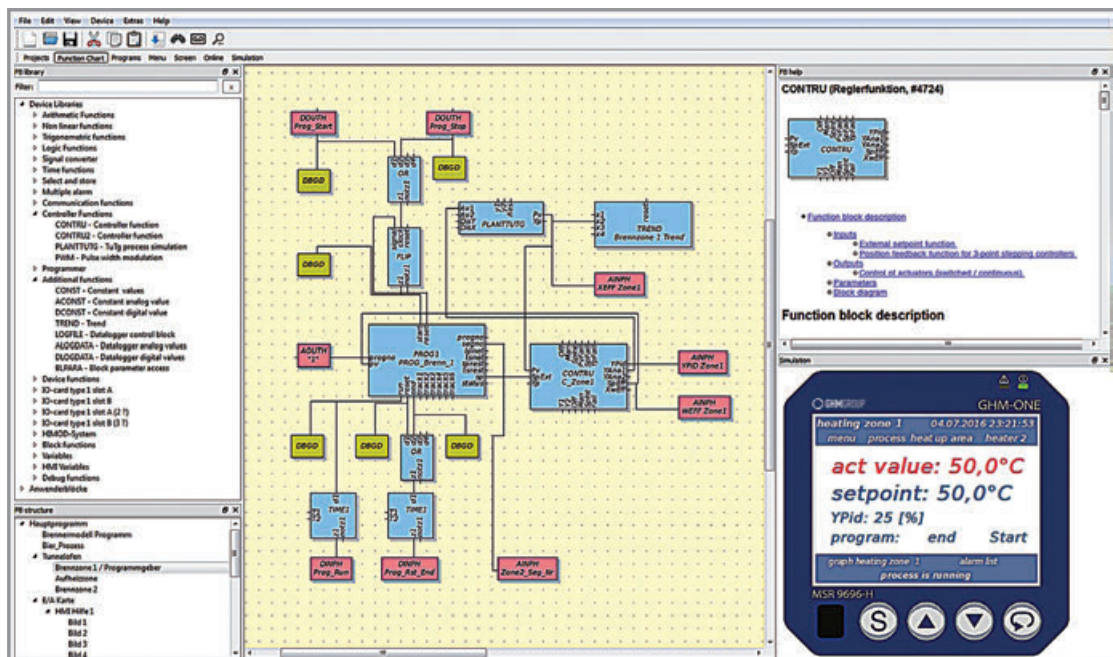

Product information Multifunction controller

Communication channels

The expansion of the MSR9696H with additional analogue and digital signals from the field is possible with the optional communications card. The expansion can take place via the GHM I/O system, in which case no additional bus coupler is required in the field. The hardware concept of the MSR 9696H also provides the possibility of connecting external I/O and other field bus participants via various field bus system

- ModbusTCP
- Modbus RTU

In the modern world of automation it is becoming increasingly important that devices exchange data with other devices M2M. The user can address this task with various interfaces to the PLC and control system level. For this purpose, the MSR 9696H offers

- ProfiNet (*currently without a certificate / certification pending)
- Profibus DP
- ModbusTCP
- Modbus RTU

as possible connections. With this communications concept, the device can be individually integrated into various process areas. In addition to I/O systems, field-bus compatible sensors and actuators connected directly to the MSR 9696H with the standard systems. The overall configuration of the process values for external communication is created exclusively in CAT.

The files required for the master systems such as ProfiNet and Profibus are included. Integration takes place with the standard systems of the respective manufacturer. Therefore, integration existing systems is possible without extensive additional work. The user relies on standards that are established in the market.

Time-saving integration of the MSR 9696H in superordinate SCADA or PLC worlds with the help of standard field buses. Simple expansion of the MSR 9696H I/O with external field bus systems.

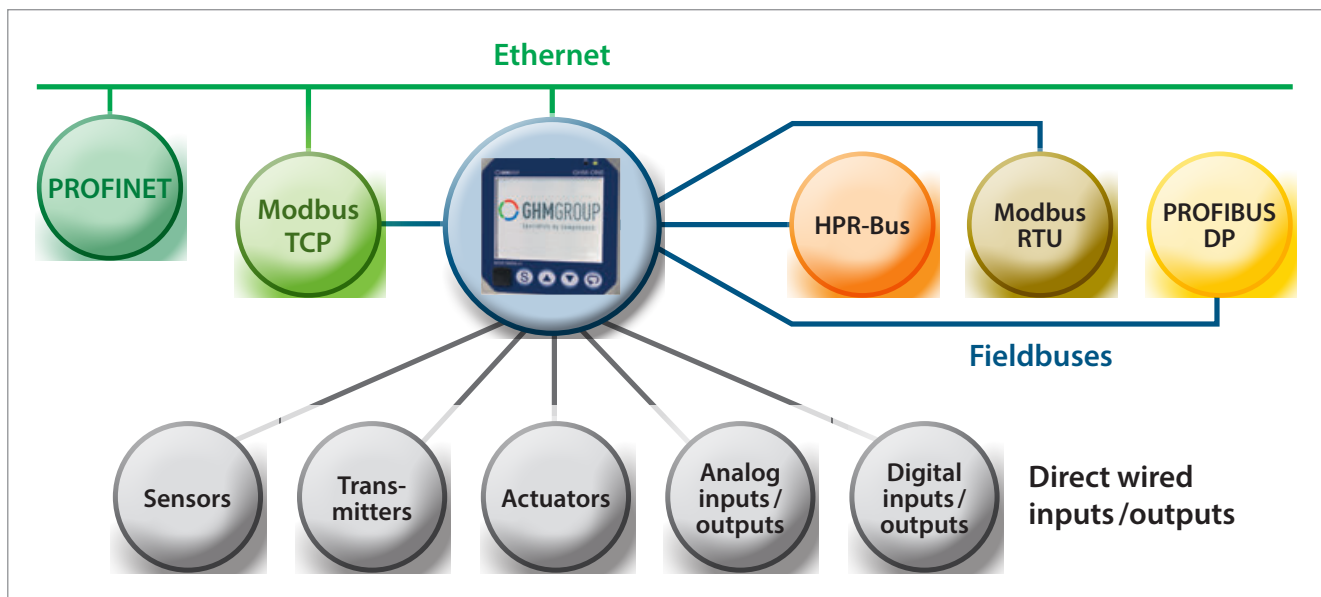

Product information Multifunction controller

Control technology, profiler

The function library provides controller modules as a basis for control-related tasks. These modules can be operated as

- 2-point controllers
- 3-point controllers
- Motor step controllers

In the process, it is possible to operate the controllers as analog or switching controllers. A wide spectrum of setpoint and actual value functions and setpoint functions round out the scope of module functions. Additional functions are available for specific tasks, such as:

- Boost function
- Soft start
- Smooth switching
- PID parameter adaptation

in order to assist the user in the realisation of tasks. With the help of several controller modules, even complex control technology structures can be implemented. This enables implementation of solutions such as

- Cascade regulation
- Limit control
- Ratio control
- Multi-Loop control / multi-variable control

and other control strategies with the assistance of standard functions. Of course, all controllers have the possibility of self-tuning.

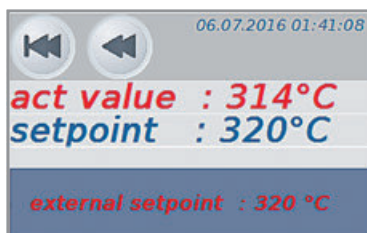

But that is not all when it comes to control technology and process control. The library also provides a profiler that is needed in many cases to adopt the control for certain processes. This is necessary whenever the material structure must be influenced over the course of a process. The profiler comprises up to 20 programs with 60 segments each. One analogue and 6 digital tracks are available per segment. The program structure is realised in CAT with simple input of the segment times and setpoints.

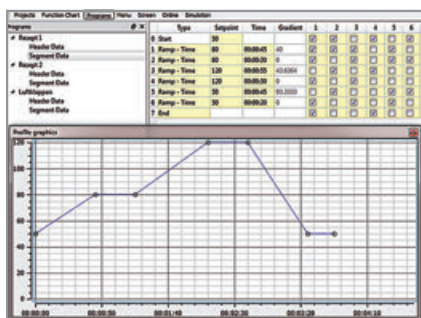

With the help of finished controller modules, realisation of control technology tasks is possible without extensive knowledge in the area of control technology.

Data recording

In many areas of industry, the recording of process data is an essential element of quality assurance. The GHM One library offers the possibility of realising a data logger and a data recorder in the device. Configuration of the data logger takes place directly in CAT with function blocks. This makes it possible to log digital and analogue signals in various time periods.

The analogue data can be recorded as minimum, maximum or mean values over a specific time period. The data is saved in the device on an eMMC chip and can be read via the Ethernet port via FTP. The device has a data storage capacity of 2GB. The readout of data via USB ports on the front and rear sides is in preparation. The data is provided to the user in a standard ASCII format (csv) for further processing and analysis.

The trend representation on the device takes place on predefined operating screens. Up to 4 curves can be represented in one trend. By cascading the function, various time periods can be represented. Since the trend block can be opened multiple times in the HMI application, it is possible to use the GHM one as a multi-channel recorder.

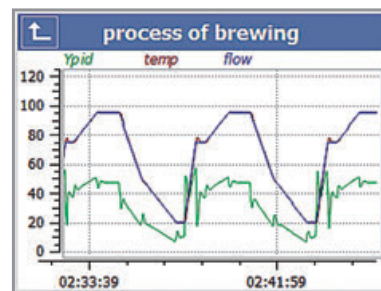

The trend representation is independent of the logger function, and so various process signals can be displayed and recorded. The library also provides an alarm block. This block can be used to display alarm lists in plain text on the device. The alarms can be acknowledged on the device and even used for further processing within the application.

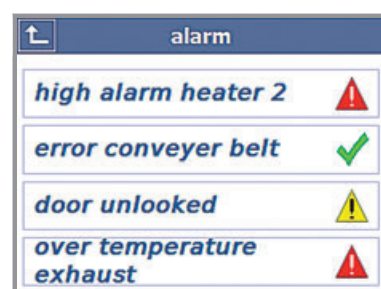

Data recording, data logging and alarming round out the performance spectrum of GHM ONE. No additional devices are required for visualisation and data backup.

Product information Multifunction controller

Device front



1. Definable red/green status display LEDs
2. 3.5" TFT colour touch display
3. 4 freely configurable operating keys
4. USB device
 - Load / read application
 - Debugging function (online representation)
 - Write / read parameters

General

- Protection rating IP 65 (front side only! rear side IP 20)
- Outside dimensions 96mm x 96 mm x 115 mm (installation length without plugs and cables)

Device rear side

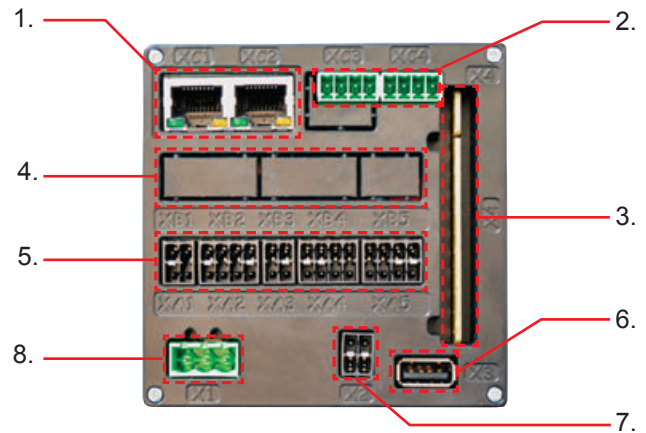

1. Ethernet communications interface
(see detailed description under 'Communication')
2. Serial RS485 Modbus / HPR bus communications interface
3. Relay card with 4 changeover contacts
(see detailed description under 'Relay outputs')
4. I/O card - slot B
(see detailed description under 'Standard I/O card')
5. I/O card - slot A
(see detailed description under 'Data transfer')
6. USB host (see detailed description under 'Data transfer')
7. Transmitter power supply
8. Power supply



- Coding protection of terminals
- Easy to use spring-type terminals
- Lockable circuit board terminal for relay connections

Overview of slots / rear side connections

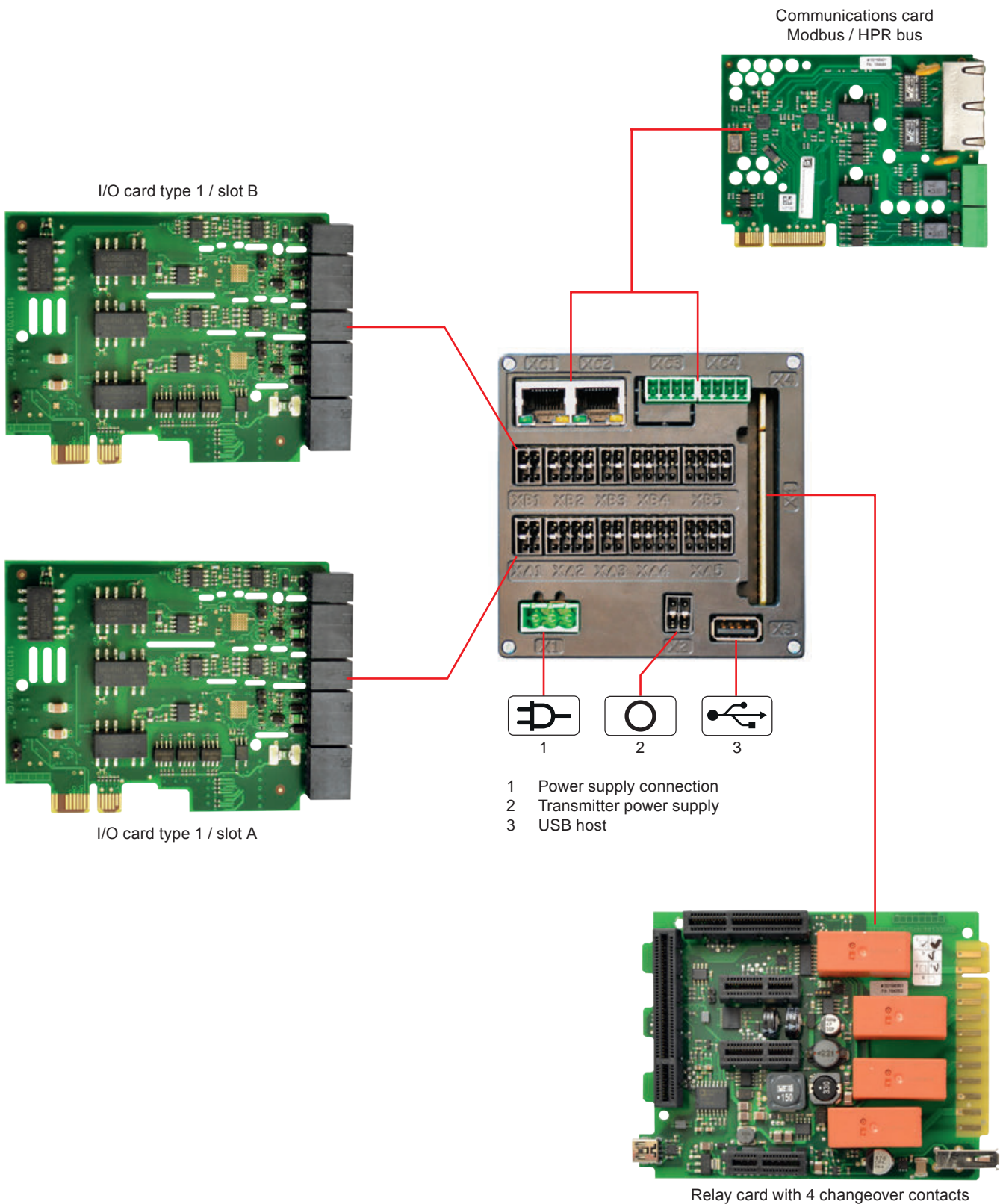

Functions in detail

MSR9696H base unit



Housing
Type : Device for control panel installation
Protection rating : IP65 front side
IP20 lens tube and rear side

Dimensions
width / height / depth : 98 mm × 98 mm × 115 mm (without plug)
98 mm × 98 mm × 130 mm (with plug)

Housing dimensions in mm

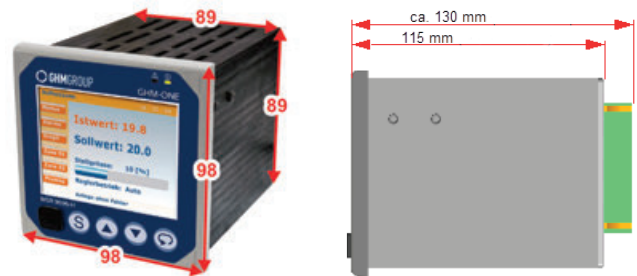

Base unit general technical data

Controls / device front

Keys : 4 freely assigned keys
Touch function : Resistive touch display

Display

Front LEDs : 1 red freely assigned LED
1 green freely assigned LED
Display : 3.5" TFT display
320 × 240 pixel QVGA resolution

Data logger

Storage medium : eMMC chip
Storage capacity : approx. 1 GB
Storage rate : >= 1 second

Auxiliary energy

Supply voltage : 100 – 240 V AC or 24 V DC
Power consumption : Typically 10W
Electrical connection : Spring-type terminal, 3-pin
Conductor cross-section : 0.25mm to 2.5mm
Galvanic isolation : I/O level / auxiliary energy / processor

Environmental conditions

Operating temperature : 0..+55 °C
Storage temperature : -20..+70 °C
Relative air humidity : 95%, non-condensing

Air and creep distances

Degree of contamination : 2
Overvoltage category : II
Maximum elevation : 2000m
Rated voltage category a : 230V
Test voltage category a : 3000 VAC 1min.
Rated voltage category b : 50V
Test voltage category b : 520 VAC 1min.

Dimensions for the control panel cutout

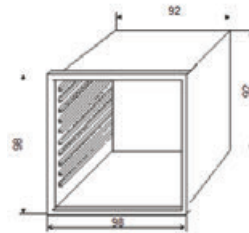

Minimum spacing between devices



Outputs (relay card)

The relay card is a base card with 4 relays designed as change-over contacts. It is not possible to exchange the relay card with other I/O cards.

Relay

Type : Changeover contacts
Number : 4
Electrical connection : Spring-type terminal
Conductor cross-section : 0.25mm to 1.5mm
Switching voltage : <250V AC < 4A

Note:

If a control contactor is connected to a relay output, an RC protective circuit (RC snubber) required according to the contactor manufacturer specifications in order to prevent high voltage peaks. Varistor protective circuits are not recommended.

Product information Multifunction controller

Option 1: I/O card type 1

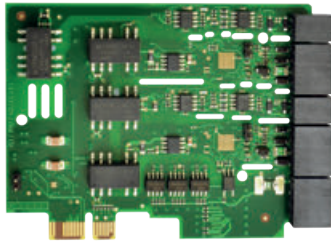

Up to 2 I/O cards can be installed in the device.
The type '1' card has:

- 2 analogue universal inputs
TC / RTD / -1000..+1000mV / 0..+20mA)
- 2 analogue standard inputs
(0..+10V / 0..+20mA)
- 2 analogue standard outputs
(0..+10V / 0..+20mA)
- 6 digital inputs or outputs

Analogue universal input

The card is equipped with 2 analogue universal inputs

Galvanic isolation

The two universal inputs are galvanically isolated from each other. There is also galvanic isolation for the power supply, the digital inputs and outputs, analogue outputs, and the processor and the communications. There is a galvanic connection to the corresponding analogue standard input (terminal X2 / terminal X4).

Converter resolution : > 18 Bit
Cycle time : 50ms
Galvanic isolation : corresponding to category a

RTD measurements

Input type : Resistance
Connection type : 3-wire

Measuring ranges

Pt100 / Pt1000	-200..+850°C
Ni100 / Ni1000	-60..+300°C
KTY 11-6	-50..+125°C

Measured current

Pt100 / Ni100	I < 0,5mA
Pt1000 / Ni 1000	I < 50µA
KTY 11-6	I < 50µA

Accuracy : ≤ 1K
Temperature drift : ≤ 0.08% / 10K
Measuring circuit monitoring : Short-circuit and interruption

Thermocouple measurements

Input type : Voltage measurement
Connection type : 2-wire
Input resistance : >10 MΩ

Thermocouples

Type	Measuring range	Accuracy	Resolution
L	-200..+900°C	≤ 2 K	0,05 K
J	-210..+1200°C	≤ 2 K	0,05 K
K	-270..+1370°C	≤ 2 K	0,08 K
N	-196..+1299°C	≤ 2 K	0,08 K
S	-50..+1760°C	≤ 2 K	0,07 K
R	-50..+1760°C	≤ 2 K	0,07 K
T	-270..+400°C	≤ 2 K	0,02 K
E	-270..+1000°C	≤ 2 K	0,04 K
B	+25..+1820°C	≤ 3 K	0,1 K
W	0..+2299°C	≤ 3 K	0,1 K

Temperature drift : ≤ 0.08% / 10K
Measuring circuit monitoring : Interruption
Cold-junction compensation : internal / auxiliary error < 2 K

Resistance measurement

Input type : Resistance measurement
Connection type : 2-wire
Measuring range : 0..20 kΩ
Detection range : Measuring range + 10%
Accuracy : ≤ 0.1%
Temperature drift : ≤ 0.08% / 10K
Measuring circuit monitoring : Exceeding the detection range

Current measurement

Input type : Current
Connection type : 2-wire
Measuring range : 0..20mA
Detection range : Measuring range + 10%
Input impedance : max. 50Ω
Accuracy : ≤ 0.1%
Temperature drift : ≤ 0.08% / 10K
Measuring circuit monitoring : Exceeding and/or undercutting the detection range

Analogue standard input

The card is equipped with 2 analogue standard inputs.

Galvanic isolation

The two standard inputs are galvanically isolated from each other. There is also galvanic isolation for the power supply, the digital inputs and outputs, analogue outputs, and the processor and the communications. There is a galvanic connection to the corresponding analogue universal input (terminal X2 / terminal X4).

Converter resolution : > 18 Bit
Cycle time : 50ms
Galvanic isolation : corresponding to category a

Current measurement

Input type : Current
Connection type : 2-wire
Measuring range : 0..20mA
Detection range : Measuring range + 10%
Input impedance : max. 50Ω
Accuracy : ≤ 0.1%
Temperature drift : ≤ 0.08% / 10K
Measuring circuit monitoring : Exceeding and/or undercutting the detection range

Product information Multifunction controller

Voltage measurement

Input type	: Voltage
Connection type	: 2-wire
Measuring range	: 0..10V
Detection range	: Measuring range + 10%
Input impedance	: typically 1.2MΩ
Accuracy	: ≤ 0.1%
Temperature drift	: ≤ 0.08% / 10K
Measuring circuit monitoring	: Exceeding and/or

Analog output

The card is equipped with 2 analogue standard outputs

Galvanic isolation

The two standard outputs are galvanically isolated from each other. There is also galvanic isolation for the power supply, the digital inputs and outputs, analogue outputs, and the processor and the communications.

Converter resolution	: 12 Bit
Linearity	: < 0.1%
Accuracy	: < 0.2%
Temperature drift	: ≤ 0.1% / 10K
Cycle time	: 50ms
Galvanic isolation	: corresponding to category a

Current output

Dynamic range	: 0..+22mA
Output resistance	: max. 500Ω

Voltage output

Dynamic range	: 0..+11V
Output load	: RL ≥ 1 kΩ

Digital inputs and outputs

The I/O card is equipped with six inputs/outputs; the function for the respective signal can be configured in CAT. The supply of the inputs/outputs must be provided externally.

Galvanic isolation

The inputs/outputs are not galvanically isolated from each other. There is galvanic isolation for the power supply, the analogue inputs and outputs and the processor and the communications.

Supply voltage	: 24V DC +/- 20%
Galvanic isolation	: corresponding to category a
Digital outputs	: maximum output current 100 mA

Counter input

Two digital inputs (Inputs 1 and 3) can be configured as counter inputs

Limit frequency	: 10kHz
Output signal	: Pulses per time unit (configurable)

Electrical connections

Electrical connection	: Spring-type terminal
Conductor cross-section	: 0.25 mm to 1.5 mm (with wire end ferrule / without plastic sleeve)
Conductor cross-section	: 0.25 mm to 0.75 mm (with wire end ferrule / without plastic sleeve)

I/O card connections

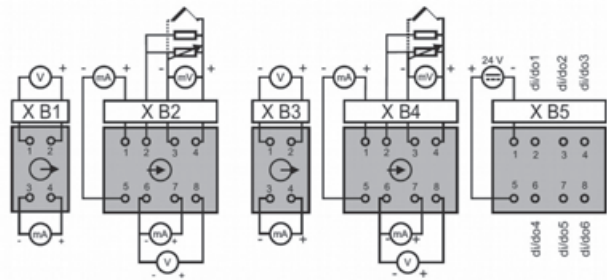

Option 2: Modbus / HPR bus communications card

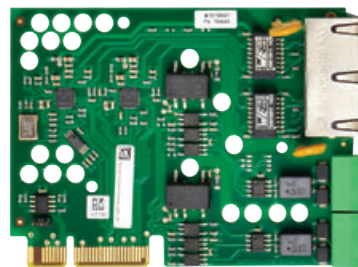

The communications card is equipped with 2 Ethernet ports (IEEE 802.3) and 2 RS485 interfaces.

Ethernet Connection	: RJ-45
Function	: 10/100 Mbit/s Auto-negotiation Auto-MDIX IP via DHCP or fix
LED	: Link / data
Protocol	: ModBusTCP Slave ModBusTCP Master FT server

Ordering code

GHM-ONE

MSR9696H - ^{1.} - ^{2.} - ^{3.} - ^{4.} - ^{5.}

GHM	
Multi-function controller	
1. I/O card slot A	
0	No card in slot A
1	I/O card with 2 universal inputs 2 standard signal inputs 2 analogue standard signal outputs 6 digital inputs or outputs
2	I/O card with 2 universal inputs 2 high-impedance mV inputs for O ₂ measurement 2 analogue standard signal outputs 6 digital inputs or outputs
2. I/O card slot B	
0	No card in slot B
1	I/O card with 2 universal inputs 2 standard signal inputs 2 analogue standard signal outputs 6 digital inputs or outputs
2	I/O card with 2 universal inputs 2 high-impedance mV inputs for O ₂ measurement 2 analogue standard signal outputs 6 digital inputs or outputs
3. Communication card	
0	No communication card
1	Communication card with 2 x Ethernet; 2 x RS485 (Modbus TCP / Modbus RTU and HPR-Bus)
2	PROFINET, Ethernet/Modbus RTU, HPR-BUS
3	1 x SUB-D (Profibus), 1 x Ethernet, 1 x RS485 (Modbus RTU and HPR-Bus)
4. Auxiliary voltage	
1	230 V AC
2	24 V DC
5. Options	
0	No options
Accessories	
USB connecting cable for connection of a PC, length 1.5 m (Art. Nr. 190064)	

Storage programm

MSR9696H-1-0-1-1-0

GHM-CAT software

GHM-CAT-LZ - ^{1.}

GHM	
1. Software licenses	
LZ1	One license dongle
LZ2	3 license dongle
LZ5	5 license dongle
LZ10	10 license dongle